

MOUNTING AND INSTRUCTION MANUAL

DTS 4138.timeserver

Network – Time Server and Master Clock



Certification of the Producer

STANDARDS

The DTS 4138.timeserver was developed and produced in accordance with the EU Guidelines:

2014 / 30 / EU	EMC
2014 / 35 / EU	LVD
2008 / 57 / EU	Railway
2011 / 65 / EU	RoHS
1907 / 2006	REACH
2012 / 19 / EU	WEEE



References to the Instruction Manual

1. The information in this Instruction Manual can be changed at any time without notice. The current version is available for download on www.mobatime.com.
2. The device software is continuously being optimized and supplemented with new options. For this reason, the newest software version can be obtained from the Mobatime website.
3. This Instruction Manual has been composed with the utmost care, in order to explain all details in respect of the operation of the product. Should you, nevertheless, have questions or discover errors in this Manual, please contact us.
4. We do not answer for direct or indirect damages, which could occur, when using this Manual.
5. Please read the instructions carefully and only start setting-up the product, after you have correctly understood all the information for the installation and operation.
6. The installation must only be carried out by skilled staff.
7. It is prohibited to reproduce, to store in a computer system or to transfer this publication in a way or another, even part of it. The copyright remains with all the rights with BÜRK MOBATIME GmbH, D-78026 VS-Schwenningen and MOSER-BAER AG – CH 3454 Sumiswald / SWITZERLAND.

Overview

1	Safety	6
2	Maintenance	9
3	General Information: Introduction.....	10
4	Displays	13
5	Installation	15
6	Operation.....	16
7	Updates	55
8	Time administration	62
9	SNMP	69
10	Power supply alternatives	73

APPENDIX

A	Connection diagrams.....	74
B	Time zone table	78
C	Alarm list.....	80
D	Troubleshooting.....	82
E	Serial Telegrams.....	84
F	Copyright Notice	89
G	Parameters	90
H	Technical data	95
I	Index.....	98
J	Connection table (to fill in)	100

Table of contents

1	Safety	6	6.5.13	Alarms	39
1.1	Safety instructions	6	6.5.14	Alarm relay	40
1.2	Symbols and Signal Words used in this Instruction Manual	6	6.5.15	Alarm mask	40
1.3	Intended Use	6	6.5.16	E-mail	41
1.4	Observe operating safety!	7	6.5.17	SNMP traps	43
1.5	Consider the installation site!	7	6.5.18	Alarm input	44
1.6	Please observe the electromagnetic compatibility!	7	6.5.19	General settings	45
1.7	Network security	7	6.5.20	Network	46
1.8	Pay attention to the instructions for the connection of the power supply	8	6.5.21	Services (network services FTP, telnet, SSH...)	48
2	Maintenance	9	6.5.22	SNMP	49
2.1	Troubleshooting: Repairs	9	6.5.23	SNMP V1 / V2c	50
2.2	Cleaning	9	6.5.24	SNMP V3	51
2.3	Disposing	9	6.5.25	Time zone selection	53
3	General Information: Introduction	10	6.6	Maintenance menu	54
3.1	Scope of Delivery	10	7	Updates	55
3.2	Technical Data	10	7.1	Important information about the update procedure	55
3.3	Introduction	10	7.2	Updating images with MOBA-NMS	56
3.4	Device types	11	7.3	Updating images with FTP	56
3.5	DTS Distributed Time System	11	7.4	Updating applications or configurations with FTP	57
3.6	MOBA-NMS - Network Management System	11	7.5	Updating images via USB	57
3.6.1	Overview of the main functions	12	7.6	Updating applications or configurations via USB	58
3.6.2	Device management	12	7.7	FTP connection	59
4	Displays	13	7.8	SFTP connection	59
4.1	LED displays front side	13	7.9	SCP connection	60
4.2	LED indication back side	13	7.10	Save Configuration externally	60
4.3	Display	14	7.11	Copying Telegram files to the DTS 4138.timeserver	61
5	Installation	15	8	Time administration	62
5.1	Connections	15	8.1	Concept of time administration	62
5.2	Boot procedure of the DTS 4138.timeserver	15	8.2	Time acceptance	63
5.3	Firmware	15	8.3	Time acceptance from an external source (DCF or GPS)	63
5.4	Initial configuration	15	8.4	Time acceptance from external AFNOR-A/C, IRIG-B12x source	64
5.5	Basic settings (factory settings)	15	8.5	Time acceptance from NTP	64
6	Operation	16	8.6	NTP as backup	64
6.1	General	16	8.7	Time server	64
6.1.1	Telnet	16	8.8	Time accuracy, time-keeping	65
6.1.2	SSH	17	8.9	Leap second	65
6.1.3	Menu structure	17	8.10	NTP Authentication	65
6.2	MOBA-NMS operation	18	8.10.1	NTP symmetric keys	65
6.3	Main menu	19	8.10.2	NTP Autokey	66
6.4	Status menu	20	8.11	Redundant operation of 2 DTS 4138.timeservers	67
6.4.1	Time information and status	22	9	SNMP	69
6.4.2	Time source information	23	9.1	General	69
6.5	Configuration menu	24	9.2	Device configuration with SNMP	70
6.5.1	Lines	25	9.3	DTS subagent SNMP notification	70
6.5.2	DCF – output	25	9.3.1	Startup [dts4138StartUp]	70
6.5.3	DCF / Pulse / Frequency output	26	9.3.2	Shutdown [dts4138Shutdown]	70
6.5.4	Serial interface	27	9.3.3	Status changed [dts4138StatusChanged]	71
6.5.5	IRIG / AFNOR / DCF-FSK Output	29	9.3.4	Configuration changed [dts4138ConfigChanged]	71
6.5.6	NTP slave clocks / time zone server	30	9.3.5	Alive Notification [dts4138Alive]	72
6.5.7	Time handling	31	9.3.6	Alarm Notification [dts4138Alarm]	72
6.5.8	Time source	32	10	Power supply alternatives	73
6.5.9	Time adjustment / Time-keeping	33			
6.5.10	Redundant operation	34			
6.5.11	NTP server	35			
6.5.12	Manual time set / Leap second	39			

APPENDIX

A	Connection diagrams	74
A.1	Front connections.....	74
A.2	Connections (rear view)	75
A.3	Plug-in spring terminals.....	77
A.4	Connection GPS / GNSS 4500, DCF 4500 or GNSS 3000	77
A.5	IRIG-B00x Digital Output TTL connection.	77
B	Time zone table	78
C	Alarm list	80
D	Troubleshooting	82
E	Serial Telegrams.....	84
E.1	General.....	84
E.2	Syntax of the telegram configuration file ...	85
F	Copyright Notice	89
G	Parameters	90
H	Technical data.....	95
I	Index.....	98
J	Connection table (to fill in).....	100

1 Safety



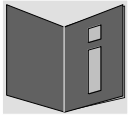

1.1 Safety instructions



Read this chapter and the entire instruction manual carefully and follow all instructions listed. This is your assurance for dependable operations and a long life of the device.

Keep this instruction manual in a safe place to have it handy every time you need it.

1.2 Symbols and Signal Words used in this Instruction Manual

	<p>Danger!</p> <p>Please observe this safety message to avoid electrical shock! There is danger to life!</p>
	<p>Warning!</p> <p>Please observe this safety message to avoid bodily harm and injuries!</p>
	<p>Caution!</p> <p>Please observe this safety message to avoid damages to property and devices!</p>
	<p>Notice!</p> <p>Additional information for the use of the device.</p>
	<p>Important information in the Manual!</p> <p>This information must be followed!</p>

1.3 Intended Use

The **DTS 4138.timeserver** is a time server for the use in network environments. It can be synchronized from NTP and be used as NTP server. In addition, it can read the time from DCF or GPS (e.g. from GPS 4500).

It can operate as master clock for a self-setting IRIG clock line. The DTS 4138 has 1 such line.

For additional functions, see the device descriptions in chapter 3.

The device is designed for 19" racks and intended to be installed in a 19" cabinet. Operate the device only in installed condition and with all connectors plugged in.

Use this product only as stated in this instruction manual. Any other use is considered improper use.



1.4 Observe operating safety!

- Never open the housing of the device! This could cause an electric short or even a fire, which would damage your device. Do not modify your device!
- The device is not intended for use by persons (including children) with limited physical, sensory, or mental capacities or a lack of experience and/or knowledge.
- Keep packaging such as plastic films away from children. There is the risk of suffocation if misused.



1.5 Consider the installation site!

- To avoid any operating problems, keep the device away from moisture and avoid dust, heat, and direct sunlight. Do not use the device outdoors.
- The device is designed for 19" racks and should only be operated installed in a 19" cabinet.



Danger! Make sure

that you wait before using the device after any transport until the device has reached the ambient air temperature. Great fluctuations in temperature or humidity may lead to moisture within the device caused by condensation, which can cause a short.



1.6 Please observe the electromagnetic compatibility!

- This device complies with the requirements of the EMC and the Low-voltage Directive.



1.7 Network security

- The default password shall be changed after the commissioning of the device.
- A reset of the password to default through hardware is not possible. Using MOBA-NMS the password can be modified. In case an access via MOBA-NMS is not possible, support effort will be needed or the device has to be sent back to the factory.
- Use encrypted services (SSH, SCP, SFTP)
- All unused services shall be deactivated: FTP, Telnet,...
- Refer to our Security Guidelines TE-801312 (see www.mobatime.com – Login area: > Customer_area > Product_Resources - 10_Timerserver_TimeCenter).

1.8 Pay attention to the instructions for the connection of the power supply

The connections are described in appendix "A Connection diagrams".



Danger! Absolutely pay attention:

Mounting, installation, commissioning and repairs of electrical devices must only be carried out by a licensed electrician. While the national installation regulations must be adhered.



For the power supply connection (**DC In1**) / (**DC In2**), two fuses in according to the performance data has to be provided (in both lines). The used fuses for the DC-supply have to be approved for DC.

Each power supply connection (**DC In1**) / (**DC In2**), needs to be realized with an all-pole disconnection device, which is installed near to the device mentioned in this manual, which is clearly labeled and good accessible.

Before working on a device or on the electrical installations the corresponding circuits have to be switched off and secured against uncontrolled power on.

In case more than one supply voltage is used (**DC In1**) / (**DC In2**), all of them have to be disconnected before starting any maintenance work.

2 Maintenance

2.1 Troubleshooting: Repairs

Please read carefully Appendix D Troubleshooting if your device does not work properly.

If you cannot rectify the problems, contact your supplier from whom you have purchased the device.

Any repairs must be carried out at the manufacturer's plant.

Disconnect the power supply immediately and contact your supplier if ...

- liquid has entered your device.
- the device does not properly work and you cannot rectify this problem yourself.

2.2 Cleaning

- Please make sure that the device remains clean especially in the area of the connections, the control elements, and the display elements.
- Clean your device with a damp cloth only.
- Do not use solvents, caustic, or gaseous cleaning substances.

2.3 Disposing



Device

At the end of its lifecycle, do not dispose of your device in the regular household rubbish. Return your device to your supplier who will dispose of it correctly.



Packaging

Your device is packaged to protect it from damages during transport.

Packaging is made of materials that can be disposed of in an environmentally friendly manner and properly recycled.

3 General Information: Introduction

3.1 Scope of Delivery

Please check your delivery for completeness and notify your supplier within 14 days upon receipt of the shipment if it is incomplete.

The package you received contains:

- DTS 4138.timeserver
- Mounting set for rack mounting consisting of:
 - 4 pcs nuts for 19" housing
 - 4 screws M6 for the nuts
 - 4 plastic discs for screws M6
- Connector set
 - 1 * spring terminal 6-pole orange
 - 3 * spring terminal 4-pole orange
 - 2 * spring terminal 2-pole orange
 - 1 * spring terminal 5-pole orange
- 2 pcs mounting tools with spring terminals

3.2 Technical Data

See Appendix "H Technical data".

3.3 Introduction

The DTS 4138.timeserver is a NTP Time Server for use in network environments. It can be synchronized by DCF or GPS (e.g. from GPS 4500), AFNOR-A/C, IRIG-B¹ and NTP, and act as a NTP server in a network.

It can be used as a master clock for NTP slave clocks, synchronized via unicast or multicast with NTP and time zone table.

It is equipped with 2 LAN interfaces for the operation in two independent networks.

In addition, the DTS 4138 provides an IRIG/AFNOR line (available as analog and digital (current loop and RS422) output), a serial interface for the output of time tele-grams as well as an output line for technical pulses (pulse/frequency/DCF).

As the "main" master clock, the DTS 4138 can synchronize other master clocks or other equipment with DCF and monitor with 1 alarm input.

The DTS 4138 can send both e-mails and SNMP traps for alerting purposes.

Using MOBA-NMS and SNMP, the DTS 4138 can be fully operated and its configuration and system status can be requested.

To maintain a redundant time source, two DTS 4138 can be linked by an optical link.

¹ With IRIG-B synchronization the date must be set manually once or by another time source (GPS).

3.4 Device types

Model:	Features:	Product no.:
DTS 4138.timeserver	According to above description with TCXO (temperature compensated quartz)	117982
DTS 4138S.timeserver	Like DTS 4138; Siemens version	117981

3.5 DTS Distributed Time System

DTS (Distributed Time System) is a system developed by Moser-Baer AG to connect decentralized master clocks, slave clock lines and time servers. For communication, standard LAN (Ethernet) is used. The DTS can be centrally operated and monitored.

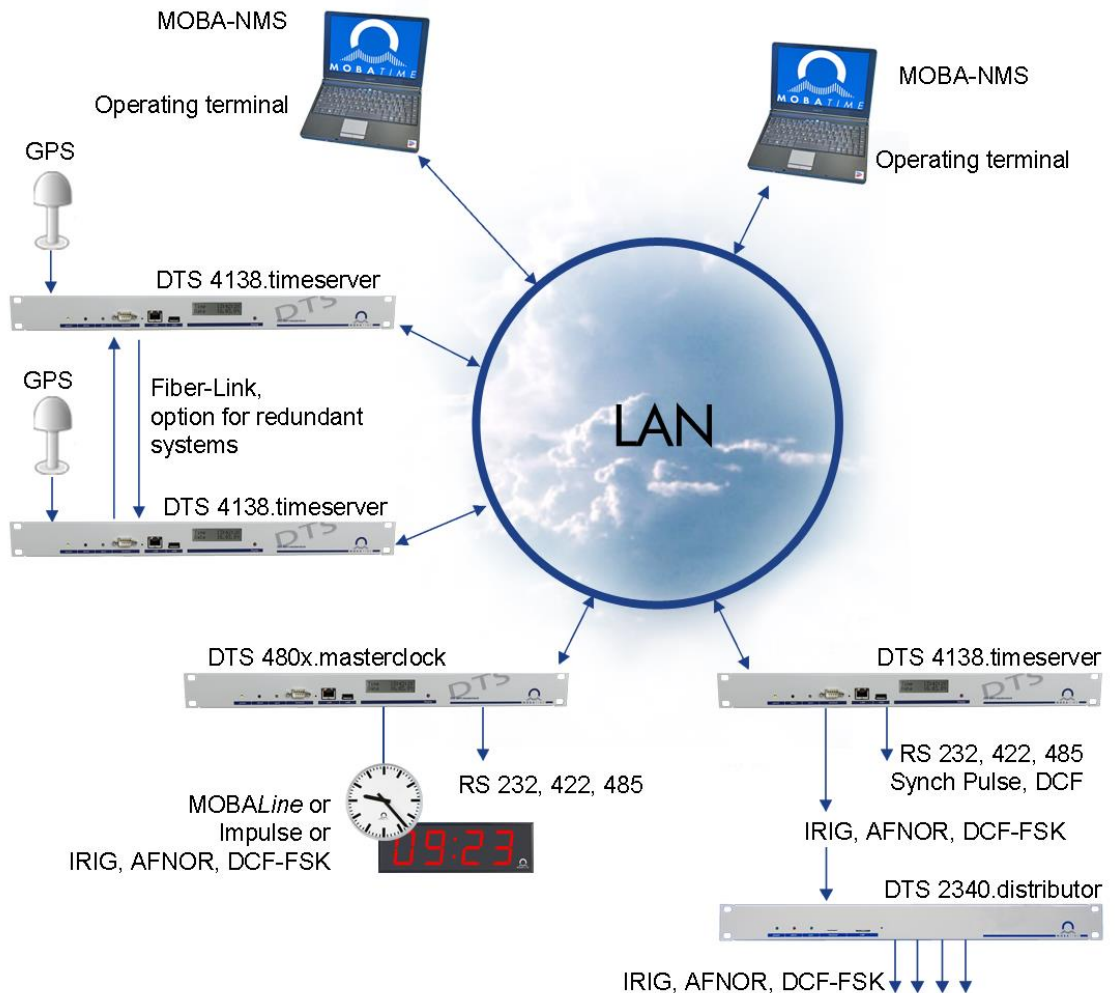

3.6 MOBA-NMS - Network Management System

MOBA-NMS is software used for central management and inquiry of state and alarm information. It supports DTS devices as well as all MOBATime analog and digital network clocks and can handle a network with more than 1000 devices. This software provides extensive functions for the configuration, installation, back-up / recovery etc. especially for DTS devices.

Due to the DTS concept, MOBA-NMS can be installed multiple times in one network. With different user rights on the device and software level, the configuration abilities of different users can be set as required.

For DTS devices, all communication is conducted over SNMP V3. The SFTP protocol is used for broadcasting files.

3.6.1 Overview of the main functions

The main MOBA-NMS functions for DTS devices and network clocks are listed below:

- automatic device scan over multicast or IP range
- device management using user-defined device groups → see chapter „3.6.2 Device management“
- intuitive user interface with input check for the device configuration
- status / alarm request and display on the device group level
- device firmware update for one or several devices (parallel)
- support for device commands, e. g. reset, restart etc.
- back-up / recovery of DTS devices
- transfer of the whole DTS configuration to another device
- user management with different access rights
- monitor for NTP and time zone packages
- editor for time zone files
- online help
- etc.

3.6.2 Device management

All MOBATime network devices are displayed in the so-called device view. Here, the devices can be grouped according to user-defined criteria. For this, the individual devices can simply be moved to the according groups and sorted using drag and drop. There is no limit to the number of groups and sub-groups.

Besides the organizational advantages (easier locating, better overview), a device group has the following advantages:

- commands and device updates can be applied to the whole group (including sub-groups).
- Alarms and errors of included devices are displayed on the group level.
- Complete groups can be moved / sorted among themselves.

The content of the device view can be saved and opened at a later time. The created structure and breakdown into groups is preserved.

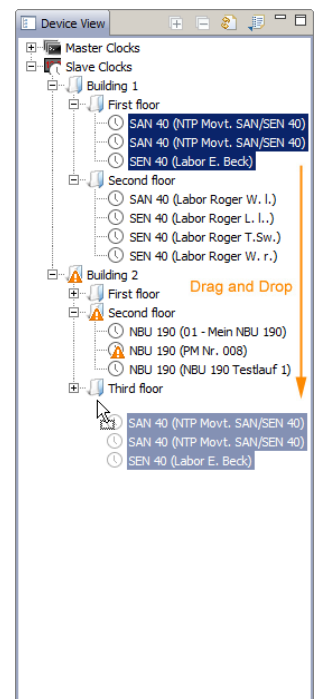

4 Displays

4.1 LED displays front side

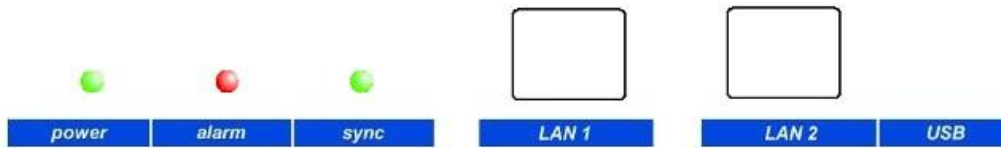

Description	Color	Status	Description
Power	Green	On Off	Mains or DC power supply is in order No power supply
Alarm	Red	On Off	The alarm relay signalizes an alarm No active alarms
Sync	Green	On Off	DTS 4138 can read the time from a synchronization source Synchronization source is not available
LAN 1 control lamps:			
Left	Green Orange	Blinking Blinking	Network activity No connection to network
Right	Yellow	Off On	10 Mbit 100 Mbit
LAN 2 control lamps:			
Left	Green Orange	Blinking Blinking	Network activity No connection to network
Right	Yellow	Off On	10 Mbit 100 Mbit

4.2 LED indication back side

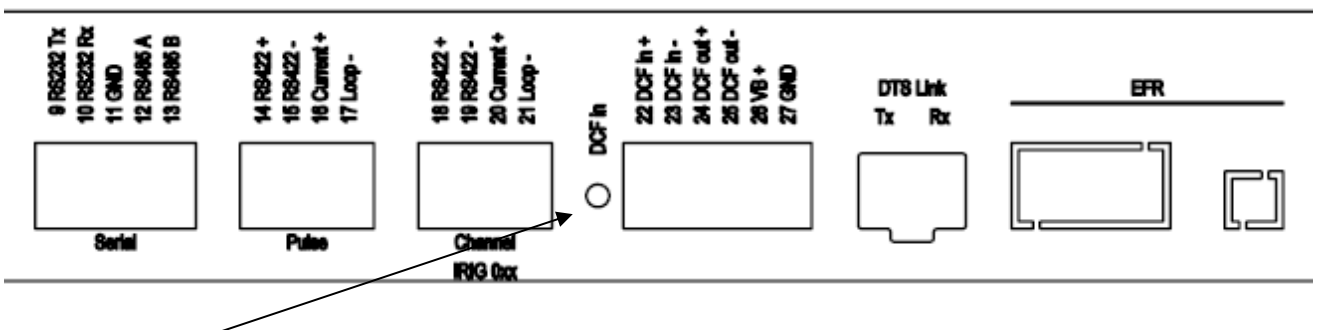

Description	Color	Status	Description
DCF in	red	Blinking	DCF (GPS reception), blinking every second → time information from receiver

4.3 Display

Display showing the current status of the DTS 4138.

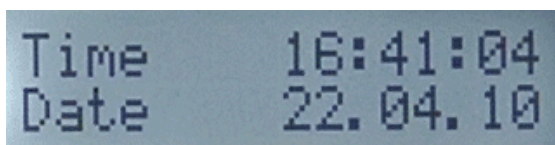

Display of:

- Time, date
- Current time source
- Stratum of the DTS 4138, status: Master / Slave
- Software version
- IPv4 address LAN 1
- IPv4 address LAN 2
- IPv6 address LAN 1
- IPv6 address LAN 2
- Alarm summary
- Current alarms

The display can be operated by means of the corresponding “Display” button:

First press the button briefly:	Switch on the background light
Other buttons to press briefly:	Scroll through all displays
Press button longer (>3 sec):	Change to default display (time and date)

The display changes after approx. 3 min without pressing the button for the default display and the background light goes off.

If a USB stick has been plugged in, it will be displayed. If only telegram files should be copied or the network settings should be changed, this can be activated directly with the button. (Press the button until the copy process starts).

5 Installation

5.1 Connections

The connections are specified in Appendix "A Connection diagrams".

Only connect the designated devices to the various inputs and outputs.

5.2 Boot procedure of the DTS 4138.timeserver

The normal booting time of the DTS 4138 is approx. 60 sec. with pre-set IP or with DHCP. After booting procedure, the text "starting" appears on the display (during the booting procedure the display is dark and empty). Without connection to a DHCP server, the first start up can take up to 75 seconds. After that, the DHCP option must be set to "off" in the network configuration.

The display "starting" remains until the time of output to the lines.
The duration, depending on the configuration, is 5-30 sec.

5.3 Firmware

It is recommended to install the current firmware on your device prior to the definite commissioning. The current firmware can be found under www.mobatime.com – Login area: > Customer_area > Product_Resources > Timeserver.

5.4 Initial configuration

Per default, the LAN 1 interface is configured with DHCP on. After booting in a network with DHCP server, the received IP address can be displayed.

The LAN 2 interface is configured with the following static settings per default:
IP 192.168.1.5, Subnet 255.255.255.0, Gateway 192.168.1.1

If these possibilities do not work out for the initial configuration, the network configuration can be modified using a USB stick. For this purpose, a text file named **DTS4138NW.conf** is created and filled with the corresponding parameters (not all parameters are required):

```
IP1:192.168.1.3  
SUB1:255.255.255.0  
GW1:192.168.1.1  
IP2:10.0.0.7  
SUB2:255.255.240.0  
GW2:10.0.0.1
```

The insertion of the USB stick is displayed. For taking over the network settings, press the button until the normal time display reappears.

5.5 Basic settings (factory settings)

The basic settings can be found in the table in Appendix "G Parameters".

6 Operation

6.1 General

Operation occurs via a terminal menu or SNMP. SNMP operation is explained in chapter "9 SNMP". Operation with the terminal menu takes place either via Telnet or SSH. After a connection has been set up, the login screen is displayed:

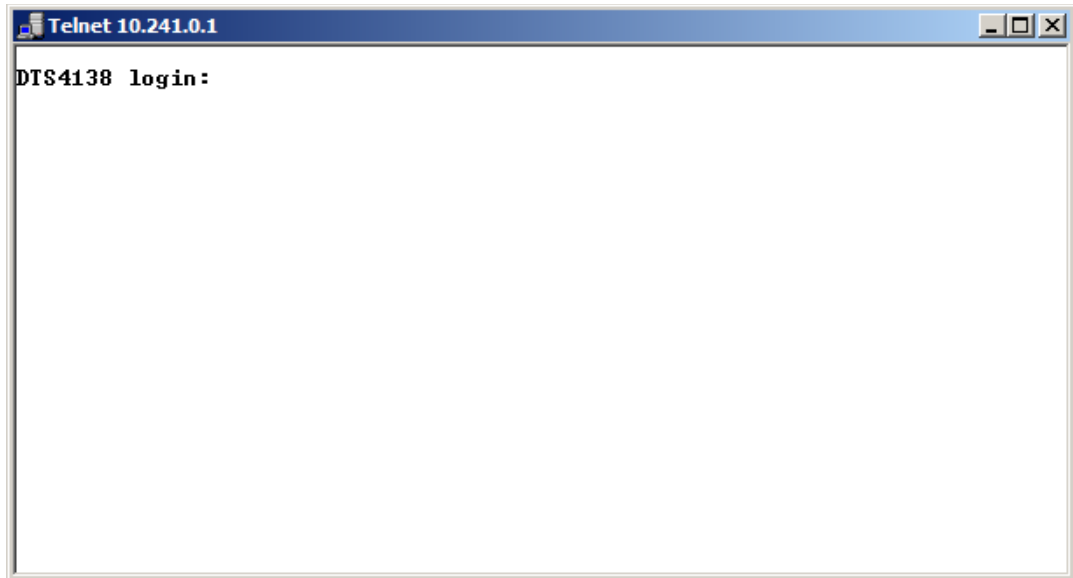

To start the menu, *dts* must be logged in as user. The standard password is *dts*. (Changing the password → see chapter "6.5.19 General settings").

Only one menu can be open at any time. The first menu started has priority. The menu is automatically closed after 15 min. without operation, and any possible connection via Telnet or SSH is interrupted.

Backspace:

Backspace must be set to "delete" with the serial terminal.

Local echo:

Some terminals (serial or Telnet) do not display the characters entered. It is, therefore, necessary to switch on the "local echo" in the terminal.

6.1.1 Telnet

Windows 8, 10, 11:

e.g. with Putty

User: *dts*

Standard password: *dts*

Linux:

Start console and enter "*telnet [IP-address]*"

6.1.2 SSH

Windows 8, 10, 11: e.g. with Putty
User: *dts*
Standard password: *dts*

Linux: Start console and enter "ssh *dts*@[[IP-address]"
Password: *dts*

6.1.3 Menu structure

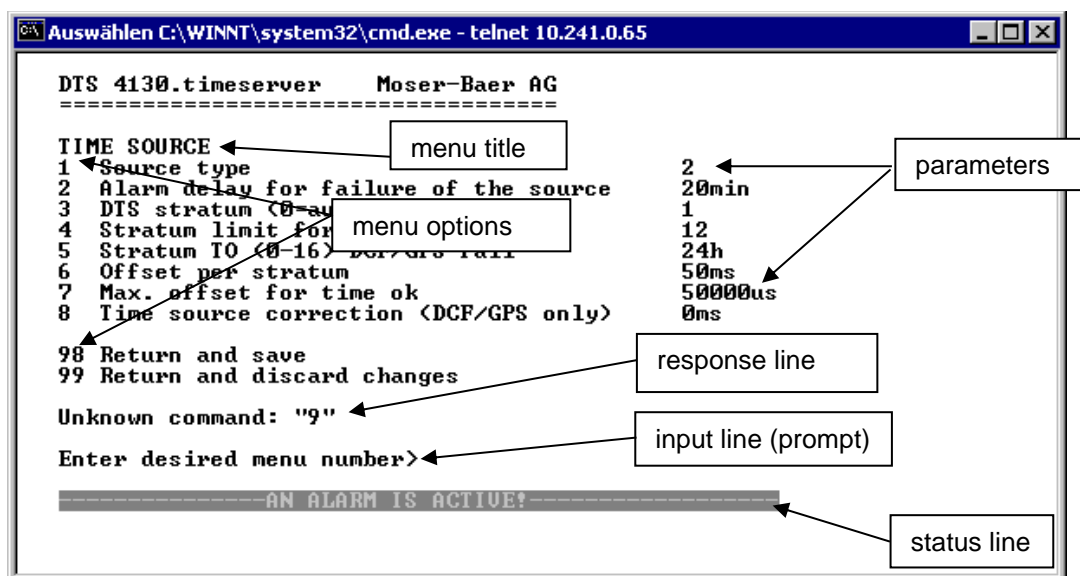

The current menu is always displayed in the **menu title**. The **menu options** show all the selectable menu functions. Provided the menu item is not a further menu, the set **parameters** are displayed. Error messages (e.g. invalid entries) or additional information to the selected menu items are displayed in the **response line**. The **input line** shows the current input values or options possible. The **status line** only appears, when an information has to be displayed, e.g. "An alarm is active".

All entries must be completed with ENTER (Return) (e.g. also ESC).

The menu window can always be exited with *Ctrl-C* (incl. termination of the Telnet and SSH connection).

The desired menu can be selected with the relevant number.

The numbers 98 and 99 are always used identically:

- With 98, the settings entered are saved and the menu exited. Depending on the change, the DTS 4138, or only partial functions, are rebooted.
- With 99, all changes to the menu are reversed and the menu exited. In the menus where data cannot be saved (command 98), the menu is only exited with 99, but any changes are not saved.

The current menu is updated, without any further entry, with ENTER.

6.2 MOBA-NMS operation

For the configuration of DTS devices via GUI, MOBA-NMS (see chapter „3.6 MOBA-NMS - Network Management System“) can be used. All configuration possibilities are subordinated in different configuration pages (called „tabs“). These tabs are connected to the terminal menu and designated accordingly. Example: The terminal menu „Configuration → Alarms“ can be found in MOBA-NMS under the tab „Alarms“.

Configuration example:

DTS 4138 (Client device 2 - Training room) x

DTS 4138
Status: OK

Firmware version: 03040612.010000.010005 [Version details...](#)

List of active alarms
(No active alarms)
[Alarm history...](#)

Network
Interface 1 | Interface 2
IPv4 | IPv6
DHCP: Off
IP address: 172.16.31.152
Subnet mask: 255.255.240.0
Gateway: 172.16.18.1
DNS server: no info
Host name: DTS4138

Power
Power supply | Quartz correction
Voltage supply 1 [V]: 25.0
Current supply 1 [mA]: 119
Voltage supply 2 [V]: 1.6
Current supply 2 [mA]: 0

Time, time state
Internal time (UTC): Feb 12, 2018 4:08:03 PM
Stratum and status: 1 MASTER
Last measured drift: 0.0078ppm
Last quartz correction (UTC): Feb 12, 2018 2:58:01 PM
Time source: GPS-DCF
Offset to source [us]: 0
Last time info from source: Feb 12, 2018 4:07:01 PM
Jitter of the source [us]: 0
Quality of the source: 100%

Source
Local | NTP
Actual measured offset: 0s 0us
Last time received DCF: Feb 12, 2018 4:07:00 PM
Sec. counter DCF: 17
Last time received link: Jan 1, 1970 12:00:00 AM
Sec. counter link: 0

NTP state
[Show NTP status details...](#)

Next refresh: 2 min. 14 sec.

Overview | Outputs | Time handling | Alarms | Network | SNMP | General, Services

configuration pages
(tabs)

For further details on the general MOBA-NMS operation, check the integrated online help (menu „Help → Show help“).

Important: To enable the communication between MOBA-NMS and the DTS devices, SNMP must be activated! Set terminal menu „Configuration → SNMP → SNMP Mode“ to „on“. SNMP is activated by default.



6.3 Main menu

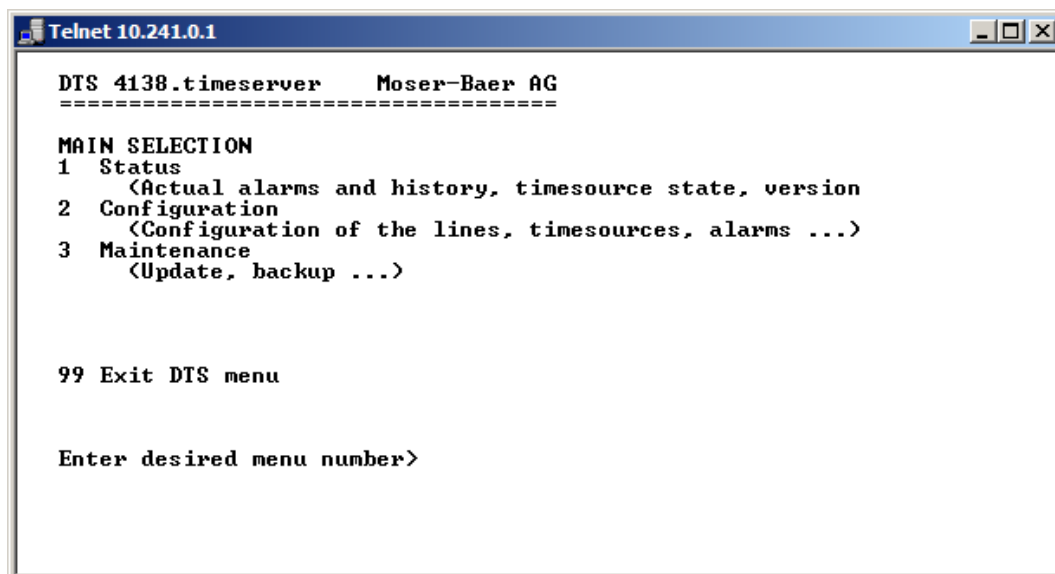

```
Telnet 10.241.0.1
DTS 4138.timeserver  Moser-Baer AG
=====
MAIN SELECTION
1  Status
   (Actual alarms and history, timesource state, version)
2  Configuration
   (Configuration of the lines, timesources, alarms ...)
3  Maintenance
   (Update, backup ...)

99 Exit DTS menu

Enter desired menu number>
```

Menus:

- Status: Display of various information regarding operation and environment
See chapter "6.4 Status menu"
- Configuration: Configuration of the DTS 4138
See chapter "6.5 Configuration menu"
- Maintenance: Software update, backup and restore
See chapter "6.6 Maintenance menu"

6.4 Status menu

The status menu consists of 2 pages.

Status menu page 1:

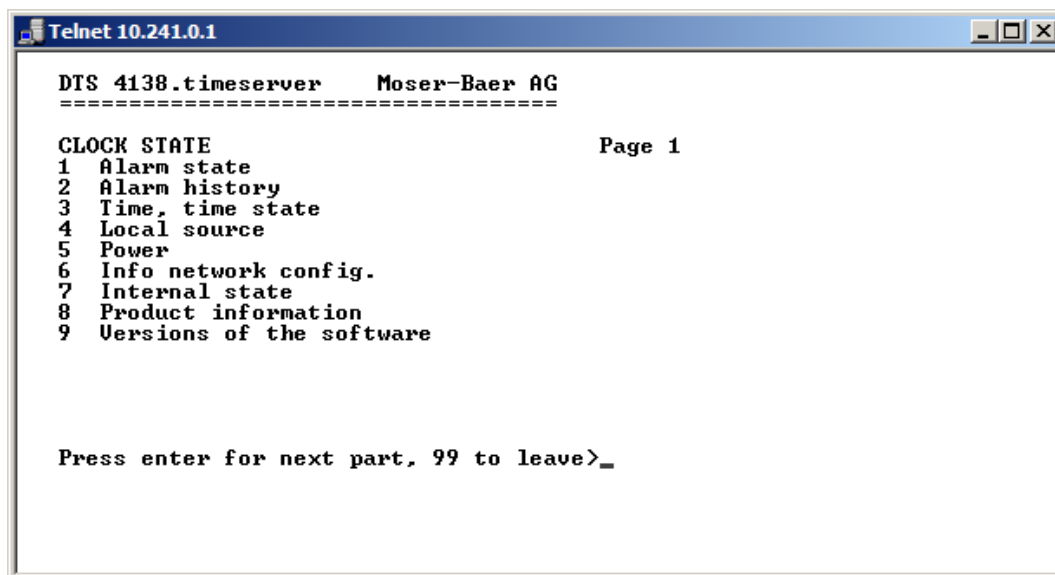

```
Telnet 10.241.0.1
DTS 4138.timeserver  Moser-Baer AG
=====
CLOCK STATE                                     Page 1
1 Alarm state
2 Alarm history
3 Time, time state
4 Local source
5 Power
6 Info network config.
7 Internal state
8 Product information
9 Versions of the software

Press enter for next part, 99 to leave>_
```

The menu shows various information on the current operating status.

1. Requesting alarm status, display of all the DTS 4138 active errors. Display of the DTS 4138 alarms (64) on 4 pages. The ALARM DETAIL menu pages can be scrolled through with ENTER. Active alarms are displayed with a *. The ALARM DETAIL menu page can be exited with 99. All DTS 4138 active alarms are displayed, masking (e-mail, traps, relay) only occurs later.
2. Alarm history display. Display of the DTS 4138 alarm record, newest alarm first. The ALARM RECORD menu pages can be scrolled through with ENTER. The ALARM RECORD menu page can be exited with ESC. Max. length of error report: 240 messages.
3. Current time and status display. See chapter "6.4.1 Time information and status"
4. Time source information display. See chapter "6.4.2 Time source information"
5. Power supply information (current, voltage) display.
6. Current network configuration display. With ENTER, a second page can be displayed with network information.
7. DTS 4138 system information display (internal status, regulation voltage of the quartz..). This information is for support purposes only.
8. Product information like serial number, firmware version etc.
9. All respective software versions of the DTS 4138 components.

Status menu page 2:

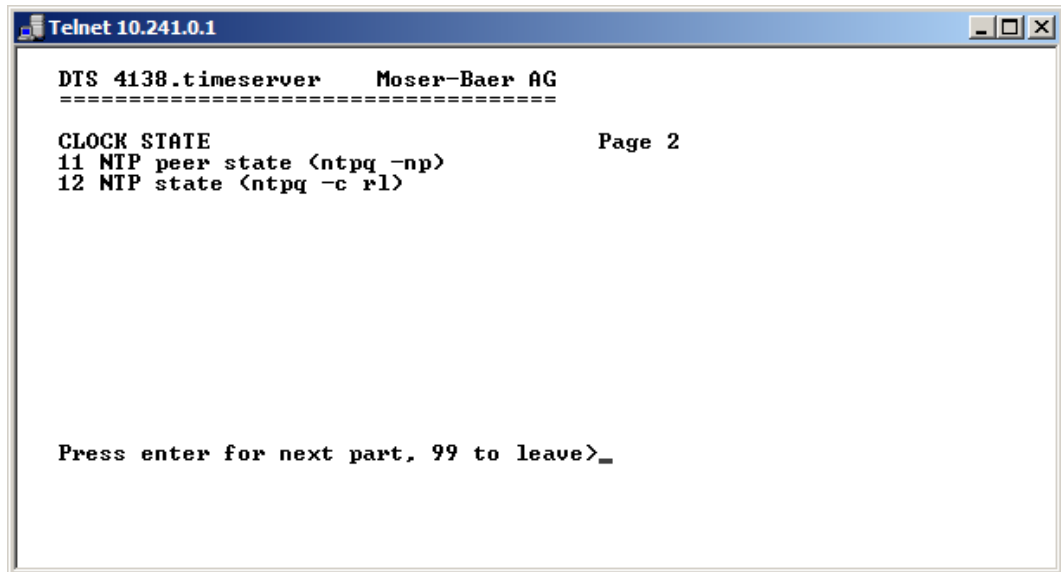

```
Telnet 10.241.0.1
DTS 4138.timeserver  Moser-Baer AG
=====
CLOCK STATE                               Page 2
11 NTP peer state <ntpq -np>
12 NTP state <ntpq -c r1>

Press enter for next part, 99 to leave>_
```

Display of information with regard to the internal state of the NTP server.

6.4.1 Time information and status

```
Telnet 10.241.0.1

DTS 4138.timeserver      Moser-Baer AG
=====

TIME INFORMATION AND STATUS
Internal time of the DTS <local time>      16:54:44 08.08.12
Stratum and state of DTS                    1 MASTER
Last measured drift                         0.0107ppm
Last quartz correction                      14:53:01 08.08.12 UTC
Time source                                 GPS <DCF>
Offset to source                            0us
Last time information from source           14:54:01 08.08.12 UTC
Jitter of the source                        0us
Quality of the source                       100%

99 Return

Enter desired menu number>
```

- Internal time of the DTS: local time
- Stratum and status of the DTS: current stratum, status: MASTER, SLAVE, not defined
- Last measured drift: drift before the last quartz correction
- Last quartz correction: time of the last quartz correction
- Time source: current time source
- Offset to source: offset to source (source – system time)
- Last time info. from source: time of the last information from source
- Jitter of the source: current jitter
- Quality of the source: quality of the source

6.4.2 Time source information

```

Telnet 10.241.0.1
DTS 4138.timeserver Moser-Baer AG
=====
TIMESOURCE INFORMATION
Actual measured offset          0us GPS FPGA
Last time received DCF <UTC>    14:55:00 08.08.12 <7>
Sec. counter DCF                19
Last time received link <UTC>   14:55:00 08.08.12
Sec. counter link               19
NTP source                      Antenna <DCF/GPS>
NTP source offset               0us
NTP source jitter               1us
NTP source stratum              0

99 Return

Enter desired menu number>_

```

- Currently measured offset: last measured offset with source info and type of measurement (only needed for Moser-Baer support).
- Last time received DCF: last time received from DCF source
In (): Information about number of available satellites (only for GPS 4500 and GNSS 3000). For DCF, this value is random.
- Sec. counter DCF: the counter is incremented by 1 with each DCF pulse. For the minute marker, the counter is set to 0.
- Last time received link: last time received from DTS Link
- Sec. counter link: analogue sec. counter DCF
- NTP – Source: current time source (system-peer) of the NTP Server
Antenna = DCF or GPS
- NTP source offset: current offset of the NTP Server
- NTP source jitter: jitter of the current source
- NTP source stratum: stratum of the current source

6.5 Configuration menu

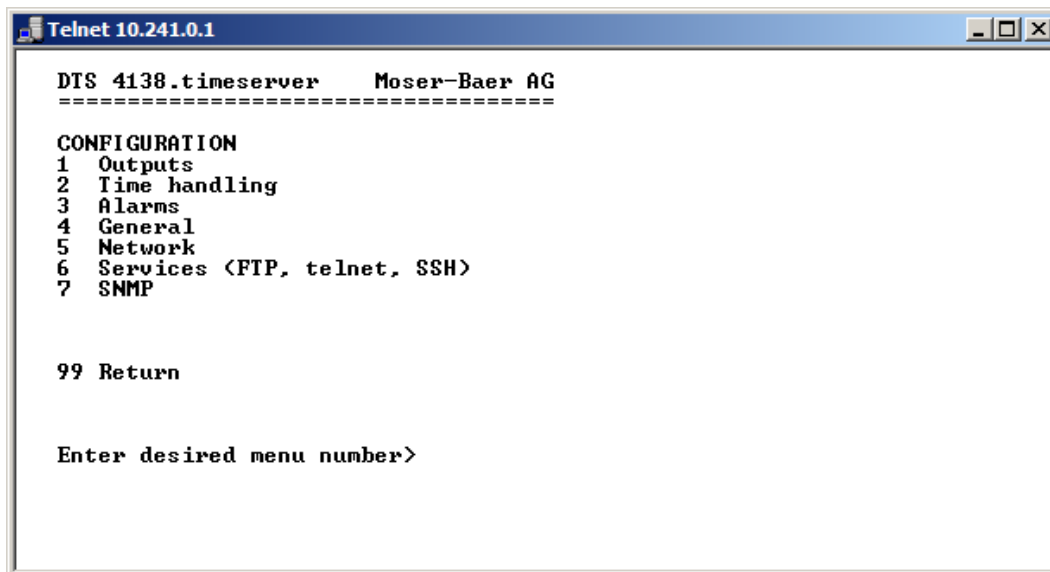

```
Telnet 10.241.0.1
DTS 4138.timeserver  Moser-Baer AG
=====
CONFIGURATION
1  Outputs
2  Time handling
3  Alarms
4  General
5  Network
6  Services <FTP, telnet, SSH>
7  SNMP

99 Return

Enter desired menu number>
```

Configuring the DTS 4138 through various submenus:

1. Configuring the lines / outputs (DCF/pulse/frequency, serial interfaces, IRIG/AFNOR/DCF-FSK and NTP slave clock line) See chapter "6.5.1 Lines"
2. Configuring the time source, time-keeping etc.
See chapter "**Fehler! Verweisquelle konnte nicht gefunden werden.**6.5.7 Time handling"
3. Alarm settings (alarm relay, e-mail, SNMP)
See chapter "6.5.13 Alarm"
4. General settings of the DTS 4138 (language, time zone for alarms and display, password for menu, power supply monitoring...)
See chapter "6.5.19 General settings"
5. Network Settings
See chapter "6.5.20 Network"
6. Services (switching network services such as FTP, Telnet, SSH on or off)
See chapter "6.5.21 Services (network services FTP, telnet, SSH...)"
7. SNMP Configuration for GET/ SET.
See chapter "6.5.22 SNMP" (Traps are described in menu '2. Configuration' → '3. Alarms' → '3. Traps'. See also chapter "6.5.17 SNMP traps")

6.5.1 Lines

Under lines, settings can be undertaken for the following functions:

- 1 DCF - Output → see chapter 6.5.2
- 2 DCF / Pulse / Frequency output → see chapter 6.5.3
- 3 Serial Interface → see chapter 6.5.4
- 4 IRIG / AFNOR / DCF-FSK output → see chapter 6.5.5
- 5 NTP slave clocks / time zone server → see chapter 6.5.6

6.5.2 DCF – output

The DTS 4138 is equipped with one DCF output line.

This line is available on the electrical current loop DCF output.

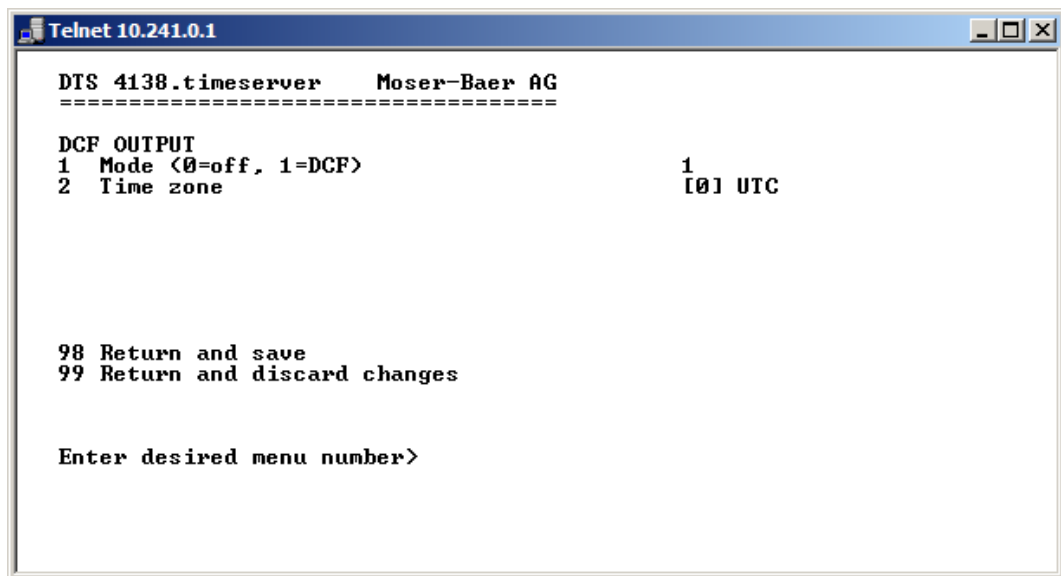

```
Telnet 10.241.0.1
DTS 4138.timeserver Moser-Baer AG
=====
DCF OUTPUT
1 Mode <0=off, 1=DCF>          1
2 Time zone                    [0] UTC

98 Return and save
99 Return and discard changes

Enter desired menu number>
```

1. Select line function: off or DCF on
2. Select time zone → see chapter 6.5.25 Time zone selection.

6.5.3 DCF / Pulse / Frequency output

```
Telnet 10.241.0.1
DTS 4138.timeserver Moser-Baer AG
=====
DCF / PULSE / FREQUENCY OUTPUT 1
1 Mode <0=off, 1=DCF, 2=pulse, 3=frequency> 1
2 Time zone [0] UTC
3 Pulse type <0=sec 1=min 2=hour 3=user> 1
4 Pulse length 150ms
5 User defined pulse type 1sec
6 Correction of output 0ms
7 Frequency 5000000Hz

98 Return and save
99 Return and discard changes

Enter desired menu number>_
```

1. Select line function: Line switched off, line DCF output, line pulse output, line frequency output
2. Select time zone → see chapter 6.5.25 Time zone selection.
3. Select pulse mode: every second, minute, hour or user-defined.
(Only active with the pulse output function)
4. Select pulse length in ms (1-500ms)
(Only active with the pulse output function)
5. User-defined pulse interval (1-3600 sec) only active with pulse type 3 (=user) (the value is also only then displayed). The pulse always occurs after a multiple of the pulse interval from the 0 second in the 0 minute, e.g.:
 - Pulse interval 960 sec. (16 min.)
→ Pulse occurs: 00:00:00, 00:16:00, 00:32:00, 00:48:00, 01:00:00, 01:16:00 ...
 - Pulse interval 25sec
→ Pulse occurs: 00:00:00, 00:00:25, 00:00:50, 00:01:15, 00:01:40, 00:02:05 ...
... 00:59:35, 01:00:00, 01:00:25 ...
6. Output correction (-500ms...+500ms)
7. Frequency (1Hz to 5MHz)



Important: Only frequencies which fulfill the following requirements are to be used, otherwise, phase shifts occur:

$$20'000'000 / \text{frequency} = \text{whole number value}$$

Important: Frequencies above 2 MHz are not sent out as a square-wave signal anymore.

6.5.4 Serial interface

Serial telegram output via RS232, RS422 or RS485.

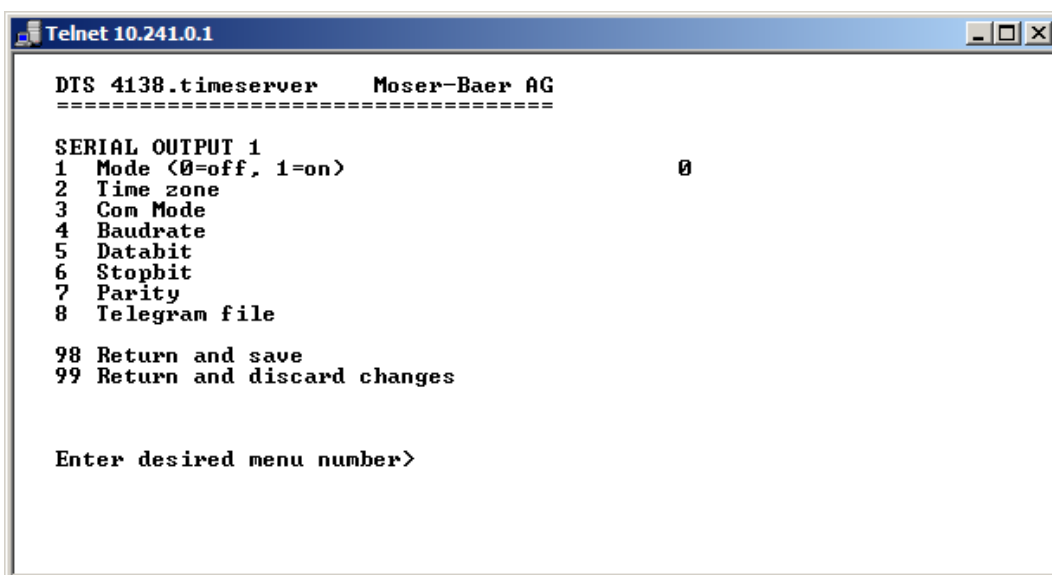

```
Telnet 10.241.0.1
DTS 4138.timeserver  Moser-Baer AG
=====
SERIAL OUTPUT 1
1 Mode <0=off, 1=on>           0
2 Time zone
3 Com Mode
4 Baudrate
5 Databit
6 Stopbit
7 Parity
8 Telegram file

98 Return and save
99 Return and discard changes

Enter desired menu number>
```

1. Select mode: Line switched off / on
2. Select time zone → see chapter 6.5.25 Time zone selection.
3. Com mode:
 - 1 = send RS 232 (receive is not enabled)
 - 2 = send and receive RS232
 - 3 = send and receive RS485
 - 4 = send RS 422 (receive is not enabled)
4. Baudrate: 300, 600, 1200, 2400, 4800, 9600, 19200, 38400
5. Data bit: 7 or 8
6. Stop bit: 1 or 2
7. Parity: none, even, odd
8. Selecting telegram file changes to the menu "SELECTION OF FILE"



Notice: To set the parameters, the line type has to be selected first.

Notice: No flow control available.

The description of the telegram function and the telegram file can be found in Appendix E Serial Telegrams.

Selection of the telegram file:

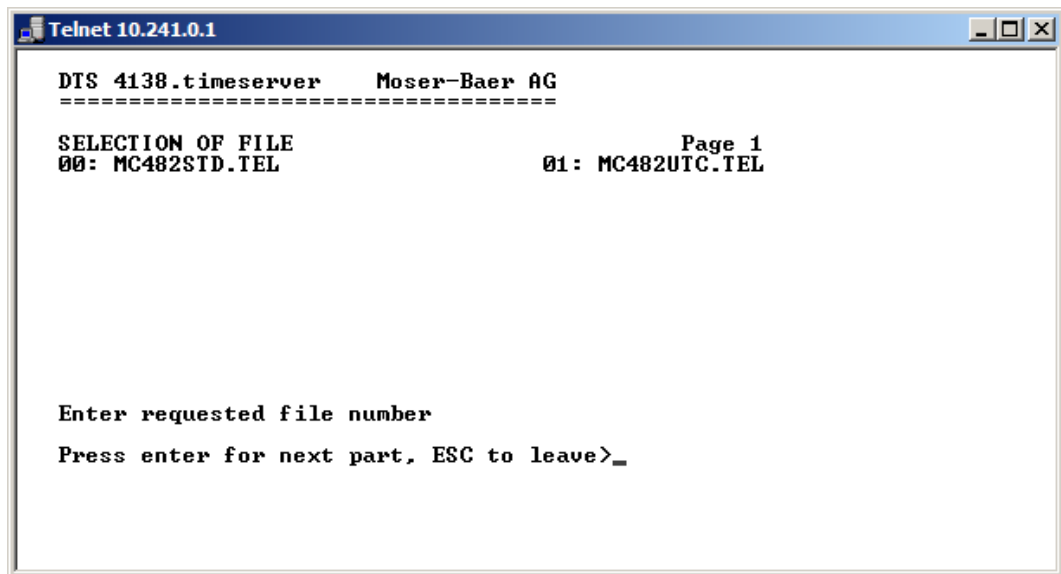

```
Telnet 10.241.0.1
DTS 4138.timeserver  Moser-Baer AG
=====
SELECTION OF FILE                               Page 1
00: MC482STD.TEL                                01: MC482UTC.TEL

Enter requested file number
Press enter for next part, ESC to leave>_
```

The copy procedure of telegram files is explained in chapter "7.11 Copying Telegram files to the DTS 4138.timeserver".

6.5.5 IRIG / AFNOR / DCF-FSK Output

```
Telnet 10.241.0.1

DTS 4138.timeserver  Moser-Baer AG
=====

IRIG / AFNOR OUTPUT 1
1  Mode                               IRIG-B126
2  Time zone                           [0] UTC
3  Level <~Upp @ Ri=Rl=500hm>          2000mU
4  Alarm signal level low <~Ueff>      200mU

98 Return and save
99 Return and discard changes

Enter desired menu number>
```

1. Select mode: see picture below
2. Select time zone → see chapter 6.5.25 Time zone selection.
3. Configuration of the output voltage level (100 – 5500 mV):
The defined voltage corresponds to the expected output amplitude when power matching (impedance matching) with a load of 50 Ohms is fulfilled. The output voltage is not controlled, resp. it is not adjusted in case of a load change.
4. Configuration of the output voltage level supervision (0 – 2000 mV):
When the output voltage falls below the defined voltage level, an alarm is released.

Selection line function:

```
Telnet 10.241.0.1

DTS 4138.timeserver  Moser-Baer AG
=====

SELECTION IRIG/AFNOR CODE
00: off
01: IRIG-B <B122>
02: IRIG-B 12h <B122>
03: IRIG-B DIEM <B122>
04: IRIG-B123
05: AFNOR-A <NFS 87-500>
06: AFNOR-C <NFS 87-500>
07: DCF-FSK
08: IRIG-E122 DIEM
* 09: IRIG-B126

Enter requested audio code

ESC to leave>
```



Notice: With the activation of one of this outputs, the modulated and the digital output are activated at the same time.
Example:
To activate IRIG-B002 output, the Code 01: IRIG-B (B122) has to be set for the corresponding output.

6.5.6 NTP slave clocks / time zone server

NTP slave clock line for operating slave clocks on the LAN (Ethernet). With this clock line, a world time function can be realized.

```
Telnet 10.241.0.1

DTS 4138.timeserver Moser-Baer AG
=====

NTP_SLAVE CLOCKS AND TIME ZONE SERVER
1 Mode(0=off 1=NTP 2=NTP+TZ 3=IZ 4=IZ poll) 0
2 Multicastaddress
3 Multicastport 65534
4 Pollinterval for NTP 0
5 Packet time to live <hops> 1
6 Repeat time to send TZ-tables <sec> 60
7 Delay time between packets <sec> 1
8 Configure time zone table

98 Return and save
99 Return and discard changes

Enter desired menu number>_
```

1. Mode of clock line: 0 = off, 1 = Send NTP multicast, 2 = Send NTP multicast and time zone table, 3 = Send time zone table, 4 = Time zones on request, 5 (only for maintenance) = Send an empty time zone table and return to previous mode.
2. Multicast address for NTP and time zone server: **239.192.54.x**
Group address: x = 1-15 for MOBATIME devices, e.g. NCI, SEN 40.
3. Multicast port for Time zone server (enter an arbitrary value, empty is not allowed! Value e.g.: 65534). The port is also needed for requesting time zone entries (mode 4).
4. Poll-interval for NTP Multicast in **2^{poll-values}** in seconds (range: 1 – 16).
E.g. poll-value = 2 → interval: 2² = 4 sec., poll-value = 5 → interval: 2⁵ = 32 sec.
For redundant Multicast time servers see remark next page.
5. Packet time to Live (TTL) for NTP- and time-zone-Multicast-packets in hops.
(Number of Routers in a network to transfer the packets through; for simple network without routing, enter value "1", for 1 Router enter "2").
6. Repeat time to send time zone table: 10 – 86400 sec.
7. Delay time between the sending of the individual time zone entries (one entry per Multicast packet) of the table: 1 – 60 sec.
8. Configuration of individual time zone entries. Displays menu "TIME ZONE TABLE".



Notice: Changes of multicast address, poll interval and TLL lead to a **restart** of the NTP server.

Notice: For the operation of a **multicast** communication (NTP and Time Zone Server) **the configuration of a gateway is required** (see chapter "6.5.20 Network"). The gateway can be set manually or by using DHCP.
If there's no gateway available, it's possible to set the own IP as gateway.



Notice: Redundant Multicast time server:

If two NTP servers in the same network should send NTP with the same Multicast IP address (redundancy), then the first time server has to be configured with a small **pollinterval** (e.g. 2 → 4 sec.) and second time server with a large pollinterval (min. 100 x larger, e.g. 9 → 512 seconds). As long as the first time server is sending NTP Multicast packets, the packets from second time server are ignored. This configuration is needed, to reach a defined situation for the end devices (the DTS with the more frequently NTP send rate gets higher priority for time reception).

Time zone table for the NTP slave clock line:

```
Telnet 10.241.0.1
DTS 4138.timeserver Moser-Baer AG
=====
TIME ZONE - TABLE
Zone01: -1 Unknown season      Zone02: -1 Unknown season
Zone03: -1 Unknown season      Zone04: -1 Unknown season
Zone05: -1 Unknown season      Zone06: -1 Unknown season
Zone07: -1 Unknown season      Zone08: -1 Unknown season
Zone09: -1 Unknown season      Zone10: -1 Unknown season
Zone11: -1 Unknown season      Zone12: -1 Unknown season
Zone13: -1 Unknown season      Zone14: -1 Unknown season
Zone15: -1 Unknown season

Enter requested entry
Press enter for next part, 99 to leave>_
```

Display of all time zone entries (15) of time zone servers for NTP slave clock lines.

Choose a zone number to change selected zone.

Time zone selection → see chapter “6.5.25 Time zone selection“.

The page can be exited with 99. Changes are first stored or reset on the overlying menu page.

6.5.7 Time handling

Under time handling, settings can be made for the following functions:

- Time source configuration → see chapter “6.5.8 Time source “
- Time adjustment configuration → see chapter “6.5.9 Time adjustment / Time-keeping“
- Redundant operation → see chapter “6.5.10 Redundant operation“
- NTP Server → see chapter "6.5.11 NTP server"
- For setting the time manually → see chapter “6.5.12 Manual time set / Leap second“

6.5.8 Time source

Time source configuration.

```
Telnet 10.241.0.1
DTS 4138.timeserver Moser-Baer AG
=====
TIME SOURCE
1 Source type                2
2 Time zone of the source    [0] UTC
3 Alarm delay for failure of the source 60min
4 DTS stratum (0=auto, 1-15=fix) 0
5 Stratum limit for synchalarm 12
6 Stratum TO (1-16) DCF/GPS fail 1h
7 Offset per stratum         50ms
8 Max. offset for time ok    50000us
9 Time source correction (DCF/GPS only) 0ms
98 Return and save
99 Return and discard changes

Enter desired menu number>_
```

1. Type of time source: 0=none, 1=DCF low quality, 2=GPS-DCF high quality, 3=NTP, 4=AFNOR-A/C or IRIG-B 12X
2. Time zone of the source: see chapter 6.5.25 Time zone selection.
3. Alarm delay at failure of time source (minutes):
0 = off, 1-2'160min, default = 0
Error: "loss of time source TO" resp. "loss of local source" in redundant mode as slave
4. DTS stratum: 0=Stratum is automatically calculated according to the time source (see chapter 8.3).
1-15= Stratum is set on a fix value
5. Stratum limits for alarm: Limits for alarm "Time source stratum lost" (1-16)
6. Stratum TO (Timeout):
Duration of stratum change 1 to 16 in the case of time loss (1-999h),
e.g. 24 hrs → stratum counts up from 1 to 16 within 24 hrs.
Default value: 12h
7. Offset per Stratum in ms (0 – 40'000 ms). Stratum is calculated with this value when time is received again:
Offset/Stratum = 30 ms, offset of the time source 150 ms → Stratum = 5
8. Max. offset for time source to set valid time in μs at start up.
(0-1'000'000μs)
9. Time source correction (only for DCF), +/-60'000ms

For description of time source see chapter "8 Time administration"

6.5.9 Time adjustment / Time-keeping

```
Telnet 10.241.0.1
DTS 4138.timeserver Moser-Baer AG
=====
TIME ADJUSTMENT CONFIGURATION
1 Adjust mode (0=follow, 1=set)           0
2 Max. catch up speed                   1000000ns/s
3 Time core type (0-255, default 0)     0
4 Synch. only offset                     0ms
5 RTC mode                               0

98 Return and save
99 Return and discard changes

Enter desired menu number>
```

1. Adjust mode: 0=time is slowly adjusted (without time steps)
1=time is set immediately
2. Maximum catch up speed in ns/s (0-10'000'000).
3. Quartz type: Standard=0 (0-255)
4. Synch. only offset: 0=off
100-5000ms=Limits as from which time is no longer accepted → Alarm "Syn only diff too great"
5. RTC mode 0=RTC deactivated
1=ON, with initial time set, independent of the mode (1)
2=ON



Notice: Explanation to the RTC mode:

RTC mode 0:

After startup of the device the system time starts at 00:00. First of all, the device has to receive the time from its time source. The time adjust happens according to the "1 Adjust mode".

RTC mode 1:

The internal real time clock (RTC) is activated. After startup of the device the system time is set with the RTC time.

The first takeover of the time from the time source happens in one step, independent from the Adjust mode (1) setting.

RTC mode 2:

The internal real time clock (RTC) is activated. After startup of the device the system time is set with the RTC time.

The time takeover from the time source happens according to the Adjust mode (1).

→ Adjust mode = 0: time is slowly adjusted

Adjust mode = 1: time is set immediately



Important! For the redundant operation, the RTC mode should be switched off!

For a description of time-keeping and adjustment see chapter "8 Time administration"

6.5.10 Redundant operation

```
Telnet 10.241.0.1
DTS 4138.timeserver Moser-Baer AG
=====
REDUNDANT OPERATION
1 Mode <0=single, 1=red., 2=red. LAN1-LAN2> 1
2 Stratum limit <1-16> 3
3 Max. offset to slave source 1000000us
4 Port for LAN link 14338
5 IP address 2. DTS 4138 10.241.0.53
6 Set master manual

98 Return and save
99 Return and discard changes

Enter desired menu number>
```

1. Mode: 0=single operation
1= redundant operation of 2 DTS 4138 (Master-Slave operation)
2= redundant operation of 2 DTS 4138 (Master-Slave operation) without LAN communication between the 2 devices.
2. Stratum limit to switch from slave to master. Standard 16 (1-16)
3. Max. offset of slaves to the slave time source for triggering the alarm "Offset Source (Slave)" (0-5'000'000us)
4. Port for LAN-Link. default 14338
5. IP address of the 2nd DTS 4138. Only required if the optical link is not working. Format 10.241.23.99
ENTER without entering an address will delete the entry.
6. Manual change from slave to master. The command is effected immediately. Saving with '98' is not required when exiting the menu.

For a description of redundant operation, see chapter "8.11 Redundant operation of 2 DTS 4138.timeservers"



Important! In redundant operation, no NTP servers may be configured as backup sources.

The redundant operation only works with GPS synchronization!

Important! For the redundant operation, the RTC mode should be switched off!

Important! LAN link in redundant mode:

For the redundant operation with additional LAN link, only the LAN 1 can be used. If this is not possible, select redundant Mode 2.

The LAN link is only used for internal communication between the two servers. It is not a redundancy for the optical link.

6.5.11 NTP server

NTP can run as server or combined as server/client. To run NTP as source (NTP as client), in the menu '2. Configuration' → '2. Time handling' → '1. Time source setting' → '1. Source type' choose NTP and set at least one server. If NTP server is configured, but NTP is not indicated as time source, NTP only runs as backup time source (redundancy) to the actual time source.

The exact behavior of NTP time sources is described in chapter "8.5 Time acceptance from NTP".

Further two multicast or broadcast addresses can be configured.

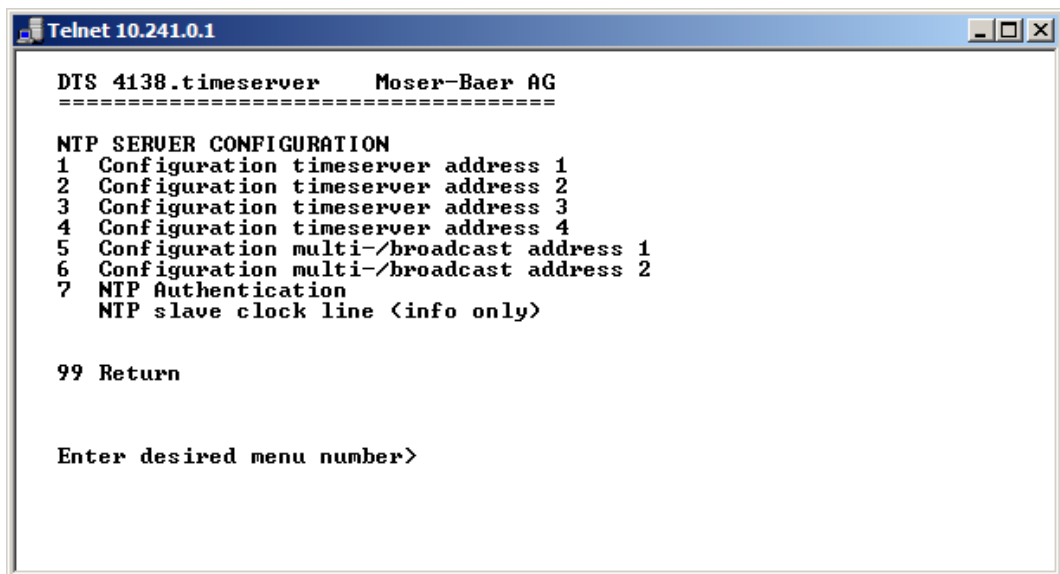

```
Telnet 10.241.0.1
DTS 4138.timeserver Moser-Baer AG
=====
NTP SERUER CONFIGURATION
1 Configuration timeserver address 1
2 Configuration timeserver address 2
3 Configuration timeserver address 3
4 Configuration timeserver address 4
5 Configuration multi-/broadcast address 1
6 Configuration multi-/broadcast address 2
7 NTP Authentication
  NTP slave clock line <info only>

99 Return

Enter desired menu number>
```

- 1.-4. Summary about configured NTP – time sources. Select to configure.
- 5.-6. Summary about configured NTP – broadcast addresses. Select to configure.
- 7. NTP Authentication: Changes to the menu "NTP AUTHENTICATION"
Information about a multicast – address, configured for NTP slave clocks.

Configuration of the individual server/peer address is as follows:

```
Telnet 10.241.0.1
DTS 4138.timeserver  Moser-Baer AG
=====
ENTRY TIMESOURCE          1
1 Source
2 Minpoll                 0
3 Maxpoll                 0
4 Server/Peer            server
5 Prefer                  off
6 Authentication key     off

98 Return and save
99 Return and discard changes

Enter desired menu number>
```

1. Insert time sources (IP address or name, e.g. "ntp.metas.ch")
ENTER without entry of an address will delete value.
- 2.-3. Configurations of **Minpoll** and **Maxpoll**: Inquiry interval $2^{\text{poll value}}$ in seconds.
0 = automatically
e.g. poll value=2 → intervall 2: $2^2 = 4\text{sec.}$, poll value=5 → intervall 5: $2^5 = 32\text{sec.}$
Range of poll values (exponent): 1 – 16
To get an exact synchronization it's better to limit Maxpoll to 6 (64 sec.).
4. Set type of NTP inquiry: server or peer
5. Preferred source: on or off
6. Authentication key: off, key number, autokey



Notice: If a key number is entered, the entered key must also be added to the trusted keys.



Notice: All changes lead to a restart of the NTP server!



Notice: If NTP only runs as a backup (source DCF or GPS), no NTP source should be indicated as **prefer!**



Notice: Maxpoll should not be selected under 4 (16 sec), as otherwise, internal trimmung may be inaccurate.
Maxpoll and Minpoll on automatic can lead to insufficient synchronization accuracy. The specified accuracies were measured with Minpoll = 3 and Maxpoll = 6.
The configuration server should be used whenever possible.

Configuration of the Multi- / Broadcast address is as follows:

```
Telnet 10.241.0.1
DTS 4138.timeserver Moser-Baer AG
=====
NTP MULTI- / BROADCAST-ENTRY          1
1 Multi- or broadcast IP address
2 Interval                             4sec
3 TTL (only for multicast)             1hops
4 Authentication key                   off

98 Return and save
99 Return and discard changes

Enter desired menu number>
```

1. IP address of the destination network (multicast or broadcast).
ENTER without entering an address will delete the entry.
2. Interval for sending out the NTP information in seconds.
The interval is rounded after the entry to NTP standard, which only permits values of format 2^x: 1,2,4,8,16,32,64... Maximum 65536 seconds.
3. TTL (time to live) in hops. Only required for multicast.
Number of routers over which the multicast packet should be transmitted: for simple networks without a router - enter 1, for 1 router - enter value 2.
4. Authentication key: off, key number, autokey



Notice: All changes lead to a restart of the NTP server.

Configuration of the NTP authentication:

The NTP authentication is described in chapter "8.10 NTP Authentication".

```
Telnet 10.241.0.1
DTS 4138.timeserver  Moser-Baer AG
=====
NTP AUTHENTICATION
1 Import keys (from /ram)
2 Export keys (to /ram)
3 Trusted (active) keys
4 Request keys (ntpq)           off
5 Control keys (ntpd)          off
6 Autokey password
7 Autokey command

98 Return and save
99 Return and discard changes

Enter desired menu number>
```

1. Import keys (from /ram directory)
The file ntp.keys must first be copied into the directory /ram.

Notice: The file must be named exactly in this way and written entirely in small letters.

2. Export keys (to /ram directory)
The current ntp.keys file is written in the directory /ram.
3. Select the trusted keys separated by commas or space
4. Select the request key
5. Select the control key
6. Set the auto key password
7. Execute for auto key commands:
gen_iff generate the IFF certificate
gen_gq generate the GQ certificate
gen_mv* generate the MV certificate
gen_all* generate all (IFF,GQ,MV) certificates
gen_client generate the client certificate
update_server update the server certificate
update_client update the client certificate
export_iff export the IFF server certificate to /ram. Parameter password of the client

export_gq export the GQ server certificate to /ram.
export_mv* export the MV server certificate to /ram.
import_iff import the IFF server certificate from /ram.
import_gq import the GQ server certificate from /ram.
import_mv* import the MV server certificate from /ram.
clear_ram delete the certificates in /ram
clear_keys delete the certificates in the NTP key directory

Example: `export_iff myPassword` exports the IFF client certificate to /ram.

*MV schema is currently not available

6.5.12 Manual time set / Leap second

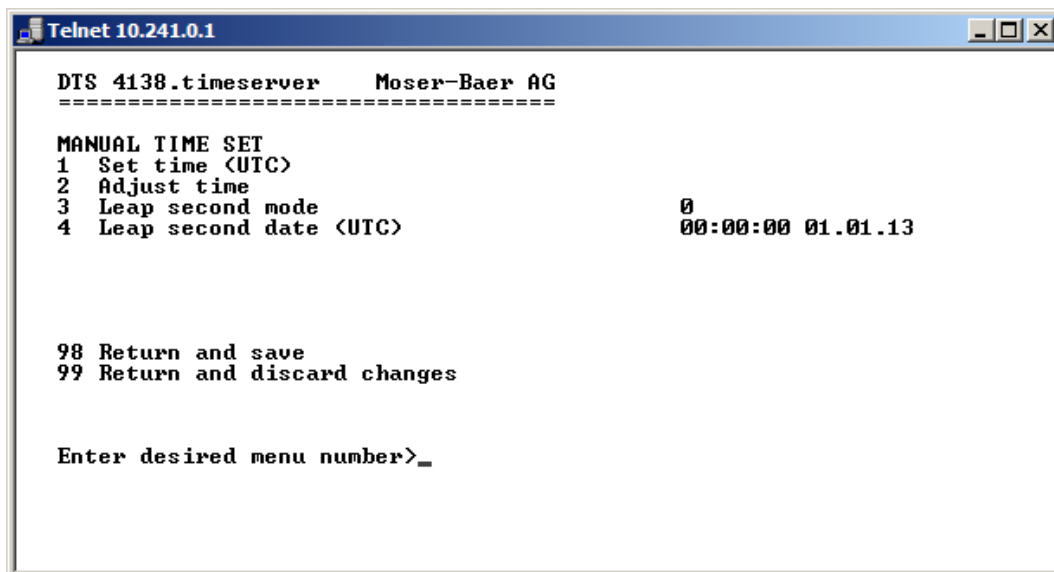

```
Telnet 10.241.0.1
DTS 4138.timeserver  Moser-Baer AG
=====
MANUAL TIME SET
1 Set time <UTC>
2 Adjust time
3 Leap second mode           0
4 Leap second date <UTC>    00:00:00 01.01.13

98 Return and save
99 Return and discard changes

Enter desired menu number>_
```

1. Set UTC time in the format “hh:mm:ss DD.MM.YY”.
Time is set with ENTER!
2. Correct time in ms (- = backwards). Range: +/-10'000ms
Time is set with ENTER!
3. Leap second mode:
 - 0 off
 - 1 Additional second will be inserted at entered time
Is set to 0=off after inserting the leap second.
 - 1 Second will be left out at entered time
Is set to 0=off after inserting the leap second.
 - 2 Recognize leap second automatically. Only possible with a source with leap second announcement!
4. Set UTC time of leap second in format: “hh:mm:ss DD.MM.YY”

For a description of the leap second, see chapter “8.9 Leap second”

6.5.13 Alarms

Under alarms, settings can be undertaken for the following functions:

- Alarm relay → see chapter 6.5.14
- E-mail → see chapter 6.5.16
- SNMP traps → see chapter 6.5.17
- Alarm input → see chapter 6.5.18

6.5.14 Alarm relay

```
Telnet 10.241.0.1
DTS 4138.timeserver Moser-Baer AG
=====
ALARM CONFIGURATION 2
1 Alarmmask for relay

98 Return and save
99 Return and discard changes

Enter desired menu number>_
```

1. Alarm mask for relay (see chapter "**Fehler! Verweisquelle konnte nicht gefunden werden.** Alarm mask")

6.5.15 Alarm mask

```
Telnet 10.241.0.1
DTS 4138.timeserver Moser-Baer AG
=====
ALARMMASK Page 1
[ ]=error disabled, [*]=error enabled
[*] Bit00: DTS restart [*] Bit01: Error bit1
[*] Bit02: Supply voltage too low [*] Bit03: Failure supply 1
[*] Bit04: Failure supply 2 [*] Bit05: Error voltage 5U
[*] Bit06: Error voltage 2.5U [*] Bit07: Error voltage 1.25U
[*] Bit08: Wrong time zone DCF [*] Bit09: Error Time Zone IC
[*] Bit10: Error bit10 [*] Bit11: Alarm input
[*] Bit12: IRIG output voltage lo [*] Bit13: Error bit13
[*] Bit14: Error bit14 [*] Bit15: Error bit15

Enter alarmnumber to alter mask
Press ENTER for next part, 99 to leave>_
```

Display of all the DTS 4138 alarms (64) on 4 pages. Pages can be scrolled through with ENTER.

An alarm on the current page can be switched on or off by entering an error number. The page can be exited with 99. The modifications will be saved or restored one menu level higher in "ALARM CONFIGURATION". All Alarms with "error bitxx" are not yet used.

A description of individual errors can be found in appendix "C Alarm list".

The alarm masks for the various applications (E-mail, SNMP, SNMP Traps, alarm relay) can differ.

6.5.16 E-mail

```
Telnet 10.241.0.1

DTS 4138.timeserver      Moser-Baer AG
=====

MAIL CONFIGURATION
1 Mailmode                off
2 Alarmmask for mail     ff ff ff ff ff ff ff ff
3 Mailserver
4 Mailport (default 25)  25
5 Destination mail address1
6 Destination mail address2
7 Reply mail address
8 From mail address

98 Return and save
99 Return and discard changes

Enter desired menu number>_
```

1. E-mail function on or off.
 2. Alarm mask for e-mail notifications (see chapter "**Fehler! Verweisquelle konnte nicht gefunden werden.** Alarm mask")
Changes are stored or reset on the overlying menu page "MAIL CONFIGURATION".
 3. IP address of the mail server e.g. 10.249.34.5
ENTER without entering an address will delete the entry.
 4. Mail server port (often 25)
 - 5.-6. Destination e-mail address.
ENTER without entering an address will delete the entry.
 7. Reply address (e.g. support, administrator...)
ENTER without entering an address will delete the entry.
 8. Sender address (important for authentication through the mail server)
ENTER without entering an address will delete the entry.
- Press ENTER to change to page 2.



Notice: Configuration of a gateway is required for sending e-mails (see chapter "6.5.20 Network"). This can be set via DHCP or manually.

E-mail configuration page 2:

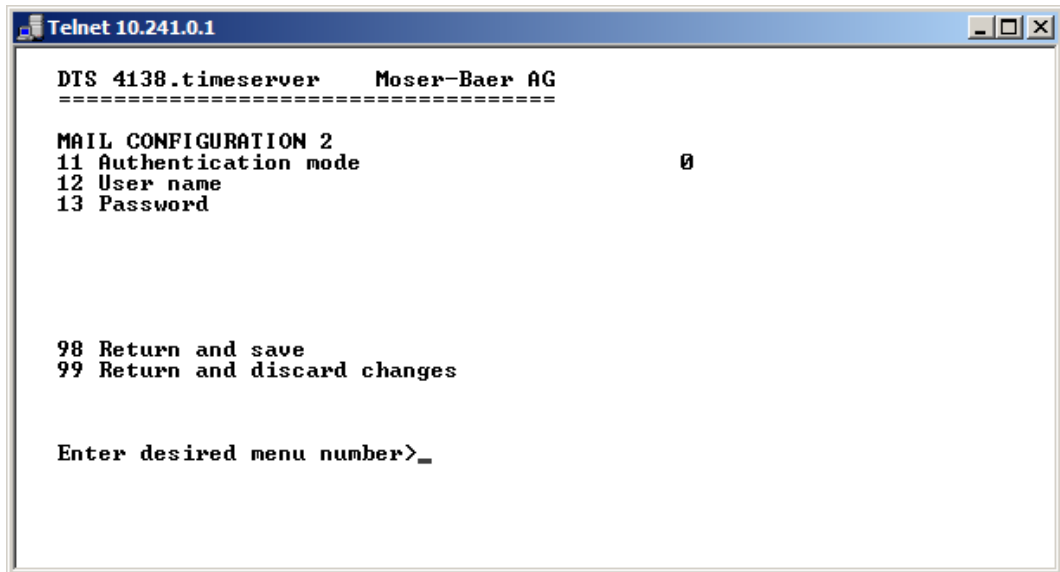

```
Telnet 10.241.0.1
DTS 4138.timeserver  Moser-Baer AG
=====
MAIL CONFIGURATION 2
11 Authentication mode          0
12 User name
13 Password

98 Return and save
99 Return and discard changes

Enter desired menu number>_
```

11. Authentication mode:
 - 0=off (sender e-mail address used for authentication)
 - 1=auto (tries CRAM-MD5, LOGIN- PLAIN in this sequence)
 - 2=PLAIN
 - 3=LOGIN
 - 4=CRAM-MD5
 12. User name (only for authentication mode 1-4)
 13. Password (only for authentication mode 1-4)
- Press ENTER to change to page 1.

Format of an error message via E-mail:

```
Event <Alarm 03 set: Power failure 1>
Time <11:26:45 10.01.07>
Hostname <DTS4138 (10.241.0.30)>
```

6.5.17 SNMP traps

For a description of SNMP functionality, see also chapter "9 SNMP". Traps are also designated as notifications (from SNMP V2)

```
Telnet 10.241.0.1

DTS 4138.timeserver  Moser-Baer AG
=====

SNMP-TRAP CONFIGURATION
1  Trap mode                      off
2  Alarmmask for trap             ff ff ff ff ff ff ff
3  Trap community string         trapmobatime
4  Configuration of destination 1
5  Configuration of destination 2
6  Time periode for alive message 0

98 Return and save
99 Return and discard changes

Enter desired menu number>_
```

1. Trap mode on or off (applies to alarm and alive traps)
2. Alarm mask for SNMP trap messages (see chapter "**Fehler! Verweisquelle konnte nicht gefunden werden.** Alarm mask")
Changes are first stored or reset on the overlying menu page "SNMP TRAP CONFIGURATION".
3. Trap community string (group membership for traps).
Standard: *trapmobatime*.
4. Configuration of the receiving system (trap sink) 1
5. Configuration of the receiving system (trap sink) 2
6. Time period for alive messages in seconds. 0 = no alive traps are sent
Range: 1-7'200sec

Notice: General settings for SNMP can be found in menu '2. Configuration' → '7. SNMP'. See also chapter "6.5.22 SNMP").

Notice: Configuration of a gateway is required for sending SNMP traps (see chapter 6.5.20 Network). This can be set via DHCP or manually.

Notice: Each configuration change leads to a restart of the DTS SNMP Agent.



Configuration of the receiving systems

```
Telnet 10.241.0.1
DTS 4138.timeserver Moser-Baer AG
=====
SNMP-TRAP DESTINATION CONFIGURATION          1
1 Address trap destination                    162
2 Port trap destination <default 162>       2
3 SNMP version

98 Return and save
99 Return and discard changes

Enter desired menu number>_
```

1. Address of the evaluation system e.g. 10.240.0.9.
ENTER without entering an address will delete the entry.
2. Port of the evaluation system (usually 162).
3. SNMP Version: 1=SNMP V1, 2=SNMP V2c



Notice: Each configuration change leads to a restart of the DTS SNMP Agent.

6.5.18 Alarm input

Description of the functionality of the alarm input.

```
Telnet 10.241.0.1
DTS 4138.timeserver Moser-Baer AG
=====
ALARM INPUT CONFIGURATION
1 Mode                                       off

98 Return and save
99 Return and discard changes

Enter desired menu number>_
```

1. Mode off, on or inverted.

6.5.19 General settings

```
Telnet 10.241.0.1

DTS 4138.timeserver  Moser-Baer AG
=====

GENERAL SETTINGS
1  Language           0
2  Timezone displayed times  [+1] Brussel
3  Power (0=single, 1=red.)  0
4  Password (menu)       dts

98 Return and save
99 Return and discard changes

Enter desired menu number>
```

1. Setting the display language
2. Setting the time zone for the display, and also all alarm logs, e-mail and SNMP.
(See chapter 6.5.25 Time zone selection).
3. Power: 0=simple power, 1=redundant power
(See chapter "10 Power supply alternatives")
4. Enter password for the menu (user **dts**) (max. 15 characters).
A password must be configured.

6.5.20 Network

```
Telnet 10.241.0.1
DTS 4138.timeserver      Moser-Baer AG
=====
NETWORK GENERAL
1  IPU4 Configuration LAN 1
2  IPU6 Configuration LAN 1
3  Network Interface LAN 1          auto
4  IPU4 Configuration LAN 2
5  IPU6 Configuration LAN 2
6  Network Interface LAN 2          auto
7  Host name <Device name>         DTS4138
8  Domain name

98 Return and save
99 Return and discard changes

Enter desired menu number>_
```

1. Configuration of IPv4 parameters LAN 1
2. Configuration of IPv6 parameters LAN 1
3. Set network interface LAN 1: Auto, 100/10Mbit, half, full duplex.
4. Configuration of IPv4 parameters LAN 2
5. Configuration of IPv6 parameters LAN 2
6. Set network interface LAN 2: Auto, 100/10Mbit, half, full duplex.
7. Set host name.



Notice: A host name must always be configured.

Host names and their format are described in the Internet standards RFC 952 and RFC 1123:

Domains and host names may only contain letters (capitals or small letters) and numerals ("0-9"). In addition, the minus sign ("-") may also be used, as long as it is not at the end.

Everything else is not permitted!

8. Set domain e.g. test.org

View of the current network state in Menu: '1 Status' → '6 Info network config.'



Notice: The menu is closed upon modifying the IP or the DHCP mode.



Notice: DHCP on/off, each change of this setting will result in a **restart** of the NTP server!



Notice: For the operation of a **Multicast** communication (NTP and Time Zone Server) **the configuration of a gateway is mandatory**. The gateway can be set manually or by using DHCP. If no gateway is available, the own IP address can be used.



Notice: Only one DNS server should be configured (IPv4 or IPv6).



- Notice:** Modifications to the network must be coordinated with the network administrator!
- Notice:** The LAN 1 gateway has priority compared to the LAN 2 gateway!
- Notice:** If only one LAN interface is used, it always has to be LAN 1!
- Notice:** The two LAN interfaces may not be configured in the same network (subnet)!

Network configuration IPv4:

```
Telnet 10.241.0.1
DTS 4138.timeserver Moser-Baer AG
=====
NETWORK IPV4                                LAN 1
1  DHCP                                      on
2  IP address                               DHCP
3  Subnet mask                              DHCP
4  Gateway                                  DHCP
5  DNS server                               DHCP

98 Return and save
99 Return and discard changes

Enter desired menu number>
```

1. DHCP on or off, the following fields are not available in case of DHCP = on. A DHCP **renew** can also be triggered via this point.



Notice: DHCP on, if no DHCP server is available, leads to longer start-up time (<75 sec.) of the DTS.

- 2.-5. Set IP address, subnet mask, gateway and DNS server. Format = 10.240.98.7

Network configuration IPv6:

```
Telnet 10.241.0.1
DTS 4138.timeserver Moser-Baer AG
=====
NETWORK IPV6                                LAN 1
1 Mode / Autoconf                            off
2 DHCPv6                                      off
3 IP address 1 / Prefix                       0::0/64
4 Gateway 1                                   0::0
5 DNS server                                  0::0

98 Return and save
99 Return and discard changes

Enter desired menu number>
```

1. Autoconf on or off
2. DHCPv6 on or off
3. IP address with prefix in IPv6 format
e.g. 2001:2345:6789::12:1:34/64
4. Gateway in IPv6 format
5. IPv6 DNS server

6.5.21 Services (network services FTP, telnet, SSH...)

Network services configuration:

```
Telnet 10.241.0.1
DTS 4138.timeserver Moser-Baer AG
=====
NETWORK SERVICES
1 telnet                                     on
2 ftp                                         on
3 ssh, scp, sftp                             on

98 Return and save
99 Return and discard changes

Enter desired menu number>_
```

- 1.-3. Switch the individual services off or on.

6.5.22 SNMP

For a description of SNMP functionality, see also chapter "9 SNMP".

```
Telnet 10.241.0.1
DTS 4138.timeserver Moser-Baer AG
=====
SNMP CONFIGURATION
1  SNMP mode                               on
2  Alarmmask for SNMP                      ff ff ff ff ff ff ff ff
3  DTS location
4  Contact information
5  SNMP U1/U2c security configuration
6  SNMP U3 security configuration

98 Return and save
99 Return and discard changes

Enter desired menu number>
```

1. Mode. 0=off, 1= V1 + V2c + V3, 2=V2c + V3, 3=V3 only
The MIB 2 SNMP information is also available with "Mode = off"

Notice: To send out MIB-2 traps, the trap community and the destination address must at least be configured in menu '2. Configuration' → '3. Alarms' → '3. Traps'. See also chapter "6.5.17 SNMP traps".

2. Alarm mask for SNMP status (see chapter "6.5.15 Alarm mask"). The modifications will be saved or restored one menu level higher in "SNMP CONFIGURATION".
3. DTS Location information, which is displayed in SNMP management tool.
4. Contact information, which is displayed in SNMP management tool.
5. Configuration of SNMP V1 / V2 c (specific settings). See chapter "6.5.23 SNMP V1 / V2c"
6. Configuration of SNMP V3 (specific settings). See chapter "6.5.24 SNMP V3"

Notice: Each configuration change leads to a restart of the DTS SNMP Agent.



6.5.23 SNMP V1 / V2c

```
Telnet 10.241.0.1
-----
DTS 4138.timeserver Moser-Baer AG
-----
SNMP U1/U2c CONFIGURATION
1 Readonly community string          romobotime
2 Read/write community string        rwmobotime

98 Return and save
99 Return and discard changes

Enter desired menu number>
```

1. Community string for **read only** (Group membership for GET).
Standard: *romobotime*.
2. Community string for **read/write** (Group membership for GET/PUT).
Standard: *rwmobotime*.



Notice: Each configuration change leads to a restart of the DTS SNMP Agent.

6.5.24 SNMP V3

```
Telnet 10.241.0.1

DTS 4138.timeserver      Moser-Baer AG
=====

SNMP V3 CONFIGURATION
1 User 1 configuration <dtsUser1>
2 User 2 configuration <dtsUser2>
3 Access 1 configuration <viewDTS1>
4 Access 2 configuration <viewDTS2>

99 Return

Enter desired menu number>_
```

1. – 2. Configuration of user-defined SNMP accounts dtsUser1 and dtsUser2
3. – 4. Configuration of user-defined SNMP access rights viewDTS1 and viewDTS2



Notice: Each configuration change leads to a restart of the DTS SNMP Agent.

User configuration SNMP V3:

```
Telnet 10.241.0.1

DTS 4138.timeserver      Moser-Baer AG
=====

SNMP V3 USER CONFIGURATION
1 Password for authent. and privacy          dtsUser1
2 Min security level                        mobatime
3 Read access <read view>                   auth
4 Write access <write view>                 _all_
                                           viewDTS1

98 Return and save
99 Return and discard changes

Enter desired menu number>_
```

1. Password for authentication (MD5) and privacy (DES). 8 – 40 characters.
2. Minimal security level:

1=noauth (no authentication)
2=auth (only authentication)
3=priv (authentication and privacy)
3. SNMP read access:

0=none (no access)
1=all (full access)
2=DTS info (only DTS specific information)
3=user defined 1 (viewDTS1)
4=user defined 2 (viewDTS2)

4. SNMP write access 0=none (no access)
 1=all (full access)
 2=DTS info (only DTS specific information)
 3=user defined 1 (viewDTS1)
 4=user defined 2 (viewDTS2)



Notice: Each configuration change leads to a restart of the DTS SNMP Agent.

Access configuration SNMP V3:

```

Telnet 10.241.0.1

DTS 4138.timeserver  Moser-Baer AG
=====
SNMP U3 ACCESS CONFIGURATION
1 Include OID 1          viewDTS1
2 Include OID 2          .1.3.6.1.4.1.8072
3 Include OID 3          .1.3.6.1.4.1.2021
4 Exclude OID 1         .1.3.6.1.4.1.13842.4
5 Exclude OID 2         .2
6 Exclude OID 3         .2

98 Return and save
99 Return and discard changes

Enter desired menu number>

```

1. - 3. Include View path, form: .1.3.6.1.4.1.13842.4 (e.g. DTS) or .iso
 (complete SNMP ISO path).
 4. - 6. Exclude View path: analogue include.



Notice: Each configuration change leads to a restart of the DTS SNMP Agent.

6.5.25 Time zone selection

```
Telnet 10.241.0.1
DTS 4138.timeserver Moser-Baer AG
=====
SELECTION TIME ZONE                               Page 1
* 00: [0] UTC                                     01: [0] London
  02: [+1] Brussel                                03: [+2] Athens
  04: [+2] Bucharest                              05: [+2] Cairo
  06: [+6] Dhaka                                  07: [+2] Tel Aviv
  08: [+3] Kuwait                                 09: [+3] Moscow
  10: [+3.5] Tehran                               11: [+4] Abu Dhabi
  12: [+4.5] Kabul                                13: [+5] Yekaterinb.
  14: [+5] Tashkent                              15: [+5.5] Mumbai
  16: [+6] Astana                                 17: [+7] Bangkok
  18: [+8] Singapore                              19: [+9] Tokyo

Enter requested time zone
Press enter for next part, ESC to leave>
```

Display of all the DTS 4138 time zones (100) over several pages. The pages can be scrolled through with ENTER.

A time zone can be selected on the current page by entering a time zone number.

Only one time zone can be selected.

A * indicates the selected time zone.

Press ESC to leave the page. The modifications will be saved or restored one menu level higher.

6.6 Maintenance menu

```
Telnet 10.241.0.1
DTS 4138.timeserver      Moser-Baer AG
=====
MAINTENANCE
1 Update software <FTP>
2 Update software <USB>
3 Backup configuration and log to USB
4 Backup configuration local
5 Restore configuration <backup>
6 Restore configuration <default MOBA>
7 Restart device
8 Copy telegram files

99 Return

Enter desired menu number>_
```

1. Initiating a software update (files must have been copied by FTP into the directory /ram of the DTS 4138 before). → See chapter "7 Updates".
The command always leads to a restart of the DTS 4138 (even if no files were copied for update).



Notice: Possibly save configuration first.

2. Initiate a software update (files must first be put on to a USB stick in the DTS 4138).
→ See chapter "7 Updates". The command always leads to a restart of the DTS 4138 (even if no files were copied for update)



Notice: Possibly save configuration first.

3. Save the entire configuration (incl. telegram files) and the log files on a USB stick .
Also generates a diagnosis file (dts4138system_XXXXXXXXXX.log) in the directory /ram which is also copied on to the USB stick or which can be downloaded per FTP (only for support).
4. Backup the entire configuration locally (→ file dts4138.conf.bkp is created).
5. Restore the entire configuration from a backup stored locally.
6. Restore the entire configuration to factory settings.
7. Restart DTS 4138.
8. Copy telegram files onto the DTS 4138.
→ See chapter "7.11 Copying Telegram files to the DTS 4138.timeserver".

See also chapter "7 Updates".

7 Updates

7.1 Important information about the update procedure

The current firmware version can be downloaded from the following web page:

<https://www.mobatime.com/support/resources/>

Enter the product name (e.g. "4138") in the search field, then select the "Firmware" tab.



Caution!

Caution: Before updating, be sure to open the CHANGELOG and follow the instructions. See also below.

To ensure that nothing is lost during the update, always make a backup of the configuration first.

We recommend to always update all images.

Update procedure from older versions:

It is mandatory to follow the procedure below, otherwise the device may stop working and have to be sent to the factory for repair!

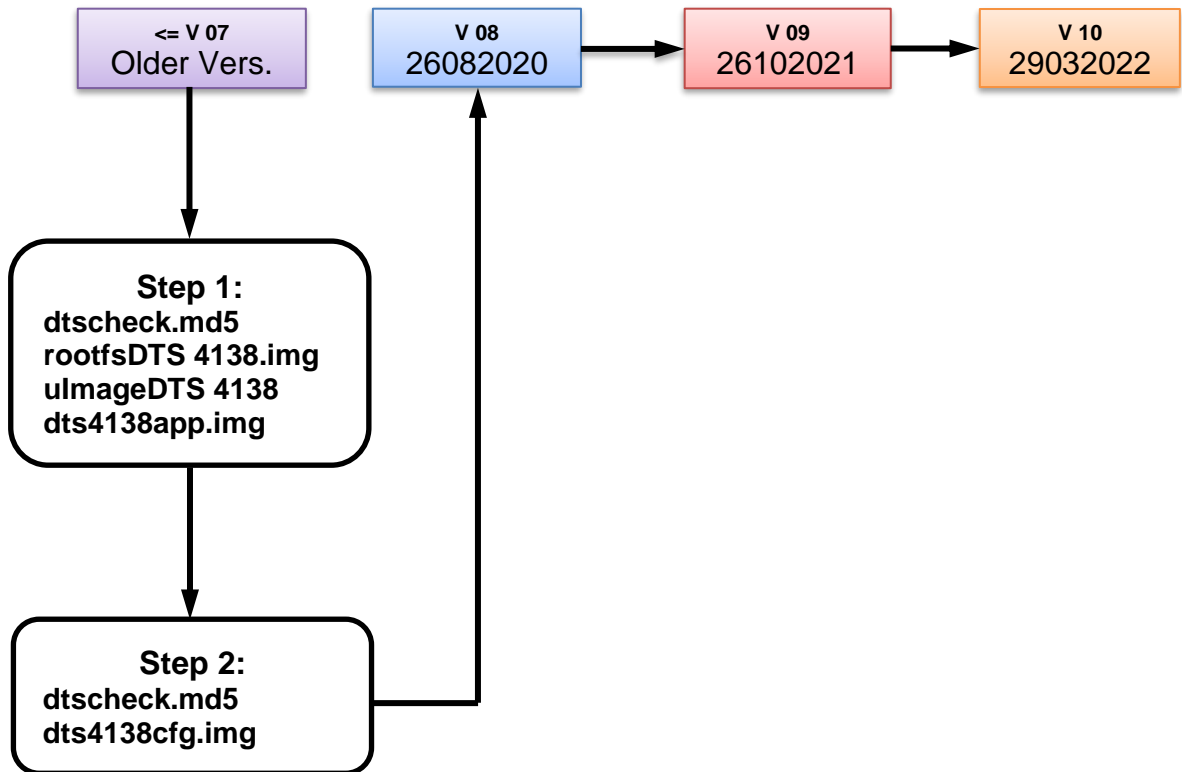

7.2 Updating images with MOBA-NMS

Steps for updating images using MOBA-NMS:

1. Select DTS device(s) in the device view.
2. Menu 'Edit' → 'Commands' → Select 'Firmware Update...'
3. Enter the path to the file 'dtscheck.md5' or select it using the 'Browse...' button.
4. Enter further paths to images or select them using the 'Browse...' button.
5. Optionally: Check the box 'Backup device(s) configuration before update' and enter the destination directory for the backup file(s). If a destination folder is selected, the whole device configuration will be saved before the backup. Additionally, if the image 'dts4138cfg.img' or 'dts4138v2cfg.img' is written too, the saved configuration can be automatically restored after the update. For this, check the box 'restore configuration after update'.
6. By clicking the 'OK' button, the update is initiated.



Important: The update procedure (item 6) can take some time (<5 min.) and may not be interrupted under any circumstances. In case of an interruption, the software on the DTS 4138 is destroyed and can only be repaired in the factory.

7.3 Updating images with FTP

Possible images are: u-bootDTS4138, rootfsDTS4138.img, ulmageDTS4138, dts4138app.img, dts4138cfg.img or dts4138v2cfg.img. Additionally the files dtscheck.md5 (old firmware) or firmwareDTS4138.sign and firmwareDTS4138.sha256 must exist. → **all file names are case-sensitive.**

Steps for updating images:

1. Connect a FTP client software to the DTS 4138 e.g. with Windows file Explorer enter: **ftp://dts@[IP address]** (as user dts).
See also chapter
2. If an update of the image **dts4138cfg.img** or **dts4138v2cfg.img** is made, the configuration of the DTS 4138 and the telegram files may be overwritten. In order to store the configuration, the file *dts4138.conf* from the directory **/etc** and any possible telegram files must be saved from the directory **/var/local/dts**. After the update, the file can again be written on the DTS 4138 in accordance with chapter "7.4 Updating applications or configurations with FTP".
3. Change to the directory **/ram**.
4. Copy the image into the directory **/ram**.
5. Close FTP connection.
6. The update procedure can be started on DTS 4138 by selecting the menu '3. Maintenance' → '1. Update software (FTP)' and press ENTER. The message "Update in progress" appears and at the same time, "Please wait!>" is shown in the command line. All images are copied. The DTS 4138 is automatically restarted on completion of the update.
The Telnet or SSH session has to be restarted.



Notice: The update procedure (point 6) may take some time depending on the type and number of images (<5 min) and must not be interrupted under any circumstances. If interrupted, the software on the DTS 4138 will be destroyed and the DTS 4138 has to be returned to the manufacturer for repairing.

Starting up after an update can also take some minutes (<10 min), or it can result in an additional restart, as the file systems have to be checked first.

To eliminate any mistakes during update procedure, the versions should be verified after the update.

7.4 Updating applications or configurations with FTP

To update individual files such as, e.g. `dts4138app`, `dts4138menu`, `ntpd`, `dts4138mod.ko`, `dts4138.conf`, etc. on the DTS 4138, the following steps are carried out
➔ **all file names are case-sensitive:**

1. Connect a FTP client software to the DTS 4138 e.g. with Windows file Explorer enter: **`ftp://dts@[IP address]`** (as user `dts`). See also chapter 7.7 FTP connection
2. Change to the directory `/ram`.
3. Copy all the files to be updated into the directory `/ram`.
4. Close FTP connection.
5. The update procedure can be started on DTS 4138 by selecting the menu '3. Maintenance' ➔ '1. Update software (FTP)' and press ENTER. The message "Update in progress" appears and at the same time, "Please wait!>" is shown in the command line. All images are copied. The DTS 4138 is automatically restarted on completion of the update. The Telnet or SSH session has to be restarted.



Notice: The update procedure (point 5) may take longer time depending on the type and number of images (<5 min) and must not be interrupted under any circumstances. If interrupted, the software on the DTS 4138 will be destroyed and the DTS 4138 has to be returned to the manufacturer for repairing.

To eliminate any mistakes during update procedure, the versions should be verified after the update.

7.5 Updating images via USB

Possible images are: `u-bootDTS4138`, `rootfsDTS4138.img`, `ulmageDTS4138`, `dts4138app.img`, `dts4138cfg.img` or `dts4138v2cfg.img`. Additionally the file `dtscheck.md5` (old firmware) or `firmwareDTS4138.sign` and `firmwareDTS4138.sha256` must exist. ➔ **all file names are case-sensitive.**

Steps for updating images:

1. Copy images to the USB stick
2. Plug the stick in the DTS 4138



Important: USB stick plugged in:

Do **NOT** press the red button, after inserting the USB stick. Start update, before main display appears again (timeout).

3. If an update of the **`dts4138cfg.img`** or **`dts4138v2cfg.img`** image is made, the configuration of the DTS 4138 and the telegram files may be overwritten. In order to store the configuration, the file `dts4138.conf` from the directory `/etc` and any possible telegram files must be saved from the directory `/var/local/dts`. After the

update, the file can again be written on the DTS 4138 in accordance with chapter "7.4 Updating applications or configurations with FTP".

4. The update procedure can be started on DTS 4138 by selecting the menu '3. Maintenance' → '2. Update software (USB)' and press ENTER. The message "Update in progress" appears and at the same time, "Please wait!>" is shown in the command line. All images are copied. The DTS 4138 is automatically restarted on completion of the update. The Telnet or SSH session has to be restarted.
5. As soon as the DTS 4138 is restarted, remove the USB stick.



Notice: The update procedure (point 4) may take longer time depending on the type and number of images (<5 min) and must not be interrupted under any circumstances. If interrupted, the software on the DTS 4138 will be destroyed and has to be returned to the manufacturer for repairing.

Starting up after an update can also take some minutes (<10 min), or it can result in an additional restart, as the file systems have to be checked first .

To eliminate any mistakes during update procedure, the versions should be verified after the update.

7.6 Updating applications or configurations via USB

To update individual files, e.g. dts4138app, dts4138menu, ntpd, dts4138mod.ko, dts4138.conf, etc. on the DTS 4138, the following steps are carried out

→ **all file names are case-sensitive, all names with 4138:**

1. Copy applications (or configuration) to the USB stick
2. Plug the stick in the DTS 4138



Important: USB stick plugged in:

Do **NOT** press the red button, after inserting the USB stick. Start update, before main display appears again (timeout).

3. The update procedure can be started on DTS 4138 by selecting the menu '3. Maintenance' → '2. Update software (USB)' and press ENTER. The message "Update in progress" appears and at the same time, "Please wait!>" is shown in the command line. All applications are copied. The DTS 4138 is automatically restarted on completion of the update. The Telnet or SSH session has to be restarted.
4. As soon as the DTS 4138 is restarted, remove the USB stick.



Notice: The update procedure (point 3) may take longer time depending on the type and number of images (<5 min) and must not be interrupted under any circumstances. If interrupted, the software on the DTS 4138 will be destroyed and the DTS 4138 has to be returned to the manufacturer for repair.

To eliminate any mistakes during the update procedure, the versions should be verified after the update.



Important: USB stick recognition:

After removing the USB stick, wait approx. 1 min. before re-inserting the it again. Otherwise it can be, that the USB stick is not recognized.

7.7 FTP connection

Establish anonymous connection:

ftp://“IP address of DTS 4138”

to directly reach the sub-directory */ram*, e.g. Windows file Explorer *ftp://10.241.0.5*

Establish connection as/with a user:

ftp://dts@“IP address of DTS 4138”.

e.g. with Windows file Explorer enter: *ftp://dts@10.241.0.5*

Password: **dts** resp. the defined password for the menu.

To directly reach the sub-directory */ram*, you can also enter

ftp://dts@10.241.0.5/ram.

Establish connection with IPv6:

The address **must** be written in brackets []:

e.g. with Windows file Explorer enter: *ftp://dts@[fd03:4432:4646:3454::2000]*



Notice: The file has to be copied in binary mode (not ASCII).

FTP tools

	Windows 8, 10, 11	Linux (Suse, Redhat)
Integrated in the system (file manager):	Windows file Explorer Start → Execute: Explorer	Konqueror / Dolphin
Programs (examples)	CuteFTP	Kbear

7.8 SFTP connection

SFTP = SSH File Transfer Protocol

SFTP tools

	Windows 8, 10, 11	Linux (Suse, Redhat)
Integrated in the system (file manager):	-	Konqueror / Dolphin
Programs (examples)	WinSCP	-

7.9 SCP connection

SCP = Secure Copy Protocol



Notice: SCP connection can only be established when no menu (operation) is open.

The following error message can be ignored. There is no influence in the functionality of the operation:

```
Command 'groups'  
failed with termination code 127 and error message  
-sh: groups: not found.
```

SCP tools

	Windows 8, 10, 11	Linux (Suse, Redhat)
Integrated in the system (file manager):	-	With command line
Programs (examples)	WinSCP	-

7.10 Save Configuration externally

(for backup or copy to another DTS 4138)

Save the current configuration via MOBA-NMS:

1. Select DTS device in the device view.
2. Menu 'Edit' → Select 'Backup configuration...'
3. Select the elements that are to be saved. (In case of doubt, select everything)
4. Click button 'Next >'.
5. Indicate destination file by clicking the 'Browse...' button.
6. Optionally: enter a free backup comment. E.g. reason for the backup, use, etc. This comment will then be shown during the restoration of the backup.
7. By clicking the 'Finish' button, the backup is created.
8. At the end of the backup, an overview of the process is shown. It shows which elements were saved and which ones are not available or could not be saved.

Save the current configuration via FTP:

1. Connect a FTP client software to the DTS 4138 (with Windows file Explorer enter: **ftp://dts@"IP address"**) (as user dts).
2. Change to the DTS 4138 directory **/etc**.
3. Save the file **dts4138.conf** (configuration) to the user PC (e.g. copy the file to the Desktop or to the directory *My Documents*).
4. Additionally also save possible telegram files from the directory **/var/local/dts**.

Save the current configuration via USB-Stick:

The whole procedure can be analogously done with an USB stick. The copy procedure to the USB stick can be started on DTS 4138 by selecting the menu '3. Maintenance' → '3. Backup configuration and log to USB' and press ENTER. All files (including telegram files) will be copied into the root directory of the USB stick.

Copy configuration to another DTS 4138:

In order to copy the entire configuration or elements of it from a DTS device to another, the according assistant in MOBA-NMS can be used. For this, select the source device (from which the configuration shall be transferred) and start the assistant in the menu 'Edit' → 'Transfer configuration...'. It will lead you through the individual steps.

Without MOBA-NMS, perform the procedure explained in chapter 7.4 resp. 7.6.

Notice: When copying the configuration from one DTS 4138 to an other, the IP address may have to be changed after the download.



7.11 Copying Telegram files to the DTS 4138.timeserver

Analogously to the previously described procedures telegram files can be copied via FTP or USB stick to the DTS 4138.

The copy procedure can be started on DTS 4138 by selecting the menu '3. Maintenance' → '8. Copy telegram-files' and press ENTER. Afterwards, select again in the menu "6.5.4 Serial interface" and reload.

The files are stored in the directory **/var/local/dts** and can be deleted or copied via FTP.

Special case USB stick:

If the DTS recognizes the insertion of an USB stick, it is shown on the display. By pressing the red button the copy procedure can be released (analogously to the above described procedure). The button has to be pressed until the copy procedure is started.

Management with MOBA-NMS:

With MOBA-NMS, the files do not need to be copied manually via FTP or USB stick, since this is already integrated in the MOBA-NMS operation. At every file selection, the 'Change...' link can be clicked. This opens a file dialog which shows all files and allows new files to be loaded onto the device or existing ones to be deleted.

Example of a program file choice:

Program file: [Change...](#)

Link for opening the file dialog for editing the file list.

Notice: After the file copy procedure, the output of the telegram files are re-started (take over of the files).

Notice: The **file name** is limited to **8 characters** before the dot, e.g. **IF482Std.tel**



8 Time administration

8.1 Concept of time administration

The internal master clock as well as the real-time clock runs with UTC (Universal Time Coordinated). The synchronisation inputs, the time shown on the display, as well as all outputs are linked via a time zone entry with the master clock time, i.e. all inputs and outputs can be individually allocated to a specific time zone.

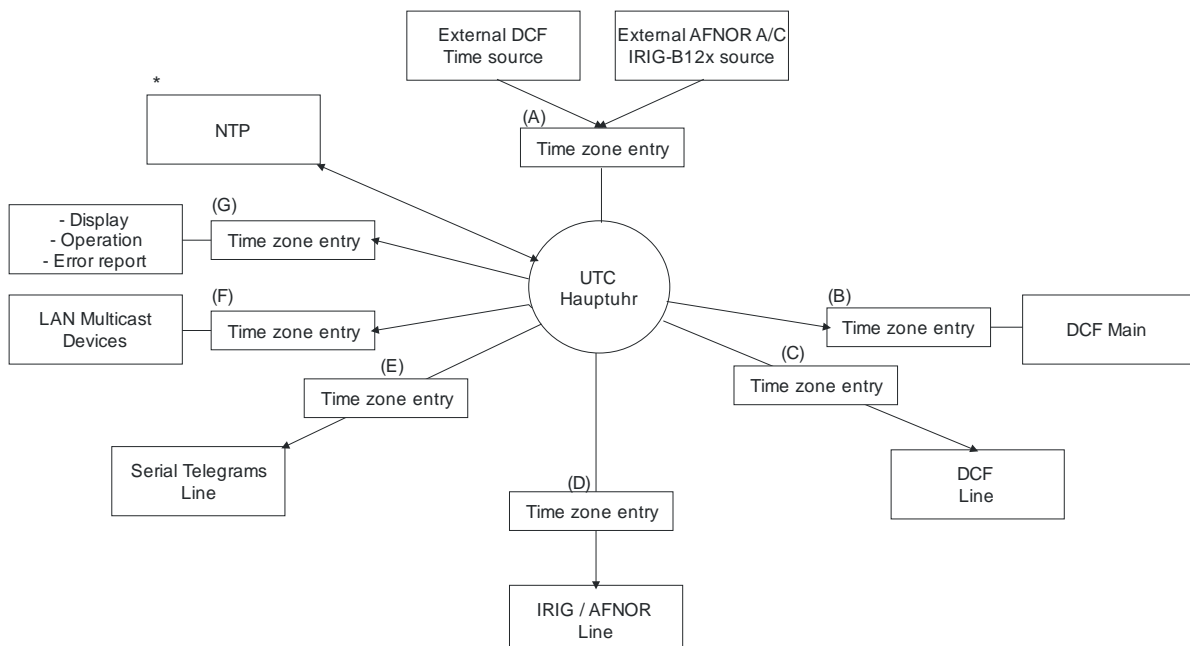

Configurable time zones:

- (A) chapter 6.5.8 Time source
- (B) chapter 6.5.2 DCF – output
- (C) chapter 6.5.3 DCF / Pulse / Frequency output
- (D) chapter 6.5.5 IRIG / AFNOR / DCF-FSK Output
- (E) chapter 6.5.4 Serial interface
- (F) chapter 6.5.6 NTP slave clocks / time zone server
- (G) chapter 6.5.19 General settings

* NTP is always UTC

8.2 Time acceptance

Variants of time synchronization

- Adjusting:
After starting the DTS 4138, the time is set for a first time (from source or manually). Afterwards, the time will only be aligned with maximum adjusting speed if deviating from the source → **no time steps possible**.
Configuration: see chapter “6.5.9 Time adjustment / Time-keeping“
- Setting:
Time deviations are always corrected in full immediately: Seconds are set immediately; partial seconds are corrected with 50ms/s.

Manual time set:

- The time is always set immediately. The stratum is set to 1 or pre-set to a fix stratum. If new source time information is available, the time will be adjusted again and the stratum set accordingly.

8.3 Time acceptance from an external source (DCF or GPS)

Acceptance from an external source (DCF input):

- At least 2 minutes reception (DCF-GPS) is required, before the NTP server is available.
Time source stratum = 0 → stratum of the DTS 4138 = 1

Stratum normal, synchronized operation:

- The stratum value behaves as follows for synchronization from the time source:
If $St_fix > 0$: then stratum = St_fix (particularly for manually set time) applies
If $St_fix = 0$: then stratum = 1

Stratum in case of error:

- The stratum value behaves as follows in the case of external time source loss:
If $St_fix > 0$: then stratum = St_fix applies
If $St_fix = 0$:
then stratum = $MIN((t_current - t_lastsynch)/(To * 255), St_max)$ applies
- Adjusting the clock after identifying a leap in time:
If $St_fix > 0$: then stratum = St_fix applies
If $Tst > 0$ AND $St_fix = 0$: then stratum = $MIN(Tdiff/Tst, St_max)$ applies
If $Tst = 0$ AND $St_fix = 0$: then stratum = 1 (auto) applies

Legend:

To:	Stratum TO <0-16>, Stratum error timeout time 1-999 [h], for loss of the external source
St_fix:	0..15, configurable stratum, 0 = auto
St_max:	1..16, configurable stratum, 0 = auto
t_current [s]:	current time
t_lastsynch [s]:	time of the last synchronization
Tst:	Offset per stratum, 0..40'000 [ms], parameter time deviation for stratum alteration by 1
Tdiff:	current time difference in ms

8.4 Time acceptance from external AFNOR-A/C, IRIG-B12x source

The stratum value is calculated same as with DCF/GPS synchronization (chapter 8.3). As IRIG-B120 to 123 time codes do not provide information about the current year, the DTS 4138 has to be synchronized first from another time source or the date has to be set manually. The DCF input and the IRIG input cannot be used at the same time for the synchronization (redundant time source with DCF and IRIG synchronization is not possible).

AFNOR and IRIG-B126 contains the **time and date** information.



Attention: After more than 5 days without power, the DTS 4138 loses the date information. When synchronized with IRIG-B120 to 123 it has to be set again manually.

8.5 Time acceptance from NTP

Acceptance:

- As NTP RFC 1305, RFC 5905 (www.ntp.org)
(see <http://ntp.isc.org/bin/view/Servers/WebHome> for internet-server)

Stratum in normal, synchronized operation:

- Stratum value of DTS is always one step higher than that of the current NTP time server

Stratum in case of an error

- As NTP RFC 1305, RFC 5905 (www.ntp.org)

8.6 NTP as backup

If DTS 4138 is synchronized with a DCF or GPS source, the NTP can be used as redundancy source. This function is active, as soon as at least one timeserver is configured in menu '2. Configuration' → '2. Time handling' → '4. NTP server'.

Stratum in normal, synchronized operation:

- Equal Stratum value "Time Acceptance from an external source (DCF or GPS)"

Behavior in case of an error:

- Failure of primary Source:
"St. exp": Means: Expected NTP Stratum of the NTP sources
"St. exp" = MAX(Stratum NTP candidates)
→ Means: "St. exp" contains the stratum value of the poorest NTP source.
If internal Stratum > "St. exp" + 1, then change to NTP as source takes place
(internal stratum is one step higher than that of the poorest available NTP source).
- As soon as the primary source is available again, the changes are set back.

8.7 Time server

- NTP v4 (compatible with v3) as per RFC 1305, RFC 5905 (Port 123)
- SNTP (UDP), RFC 2030 (Port 123)
- TIME (TCP/UDP), RFC 868 (Port 37)
- DAYTIME (TCP/UDP), RFC 867 (Port 13)

8.8 Time accuracy, time-keeping

See appendix H Technical data.

8.9 Leap second

The announcement of the switching second is put out by DCF and NTP* each time 1 hour before the defined time.

*The announcement is only sent via NTP if a DCF or IRIG source is active. If only one NTP source is configured, the state of this source is passed on.

Automatic mode

In the automatic mode, the source (DCF or NTP) is checked for a possible announcement during 1 hour prior to the moment of a possible leap second. If the announcement is recognized, it is passed through the NTP and DCF outputs and the leap second is inserted.

The leap second can be inserted at 2 moments per year: 00:00:00 1.1. or 00:00:00 1.7. each in UTC. Whether a leap second is inserted is decided by the organization IERS (<http://www.iers.org>) each time up to half a year in advance.

8.10 NTP Authentication

NTP provides two variants for authentication in version 4:

- NTP symmetric keys (i.e. symmetric keys)
- NTP autokeys

NTP authentication assures a correct time source and prevents manipulation of NTP information. NTP data itself is, however, not encoded.

8.10.1 NTP symmetric keys

A 32-bit key ID and a cryptographic 64/128-bit check sum of the packet is attached to each NTP IP packet.

The following algorithms are used for this purpose:

- Data Encryption Standard (DES)
(partly restricted in North America and no longer integrated into new NTP variants (>V4.2))
- Message Digest (MD5)

The DTS 4138 only supports the MD5 procedure.

The receiving NTP service calculates the check sum with an algorithm and compares it with the one contained in the packet. Both NTP services must have the same encryption key and the same corresponding key ID for this purpose.

Packets with a wrong key or wrong check sum will not be used for synchronization .

The DTS 4138 must be correspondingly configured to be able to use NTP authentication (chapter 6.5.11 NTP server). The NTP service of the other equipment (e.g. server, PC...) must also be configured. In the case of standard NTP, this occurs via the `ntp.conf` file:

```
# path for key file
keys /etc/ntp/ntp.keys
trustedkey 1 2 3 4 5 6# define trusted keys
requestkey 4 # key (7) for accessing server variables
controlkey 5 # key (6) for accessing server variables
```

```
server ntp1.test.org key 2
server ntp2.test.org key 6
server 192.168.23.5 key 3
```

The description of the ntp.conf file can be accessed via the corresponding man-page, or consulted at <http://www.eecis.udel.edu/~mills/ntp/html/authopt.html>

The authentication mode is automatically activated when a key is used and the paths for the keys have been correspondingly configured.

`trustedkey` defines all keys currently permitted
`requestkey` defines the key for the ntpq help tool.
`controlkey` defines the key for the ntpdc help tool.

The keys are located in the ntp.keys file defined with `keys`. This has the following format:

```
1 M TestTest
2 M df2ab658
15 M I_see!
498 M NTPv4.98
```

The key ID is in the first column of the file, the format of the keys in the second defined column, and the key itself in the third. There are four key formats, however, nowadays only the MD5 is still used → M. The letter M is no longer written for new NTP variants (>V4.2) and is only necessary for backwards compatibility.

The signs ' ', '#', '\t', '\n' and '\0' are not used in the MD5 ASCII key! Key 0 is reserved for special purposes and should therefore not be used here.

ntp.keys: man page for ntp.keys to be noted (check the internet)

8.10.2 NTP Autokey

The validity of the time received to the NTP clients is assured by symmetric keys. For a higher degree of certainty, exchanging the keys used regularly is, however, necessary to obtain protection, e.g. from replay attacks (i.e. attacks in which recorded network traffic is simply played back).

The autokey procedure was introduced as the exchange is very involved in a large network. A combination of group keys and public keys enables all NTP clients to check the validity of the time information which they receive from servers in their own autokey group.

NTP Autokey is relatively complex in its use and studying the functionality is definitely necessary beforehand.

Autokey is described at <http://www.cis.udel.edu/~mills/proto.html> or on the NTP homepage <http://www.ntp.org>.

Autokey is currently defined in an IETF draft.
<http://www.ietf.org/internet-drafts/draft-ietf-ntp-autokey-04.txt>

The configuration of Autokey is explained in
<http://support.ntp.org/bin/view/Support/ConfiguringAutokey> or in
<http://www.ntp.org/ntpfaq/NTP-s-config-adv.htm#S-CONFIG-ADV-AUTH>.

8.11 Redundant operation of 2 DTS 4138.timeservers

For redundant operation two DTS 4138 devices are synchronized via optical fibers. For this purpose, a mini GBIC module is plugged into both devices and connected via optical fibers (see Appendix H Technical data):



mini GBIC module

Both devices must have a GPS receiver in redundant operation. Both devices are configured for the redundant mode, but are basically equal and work out the master/slave role among themselves. The slave is always synchronized to the master in operation. The slave supervises the system time on the basis of its own GPS time and generates an error message, should the time difference amount exceed the configurable value of n milliseconds.

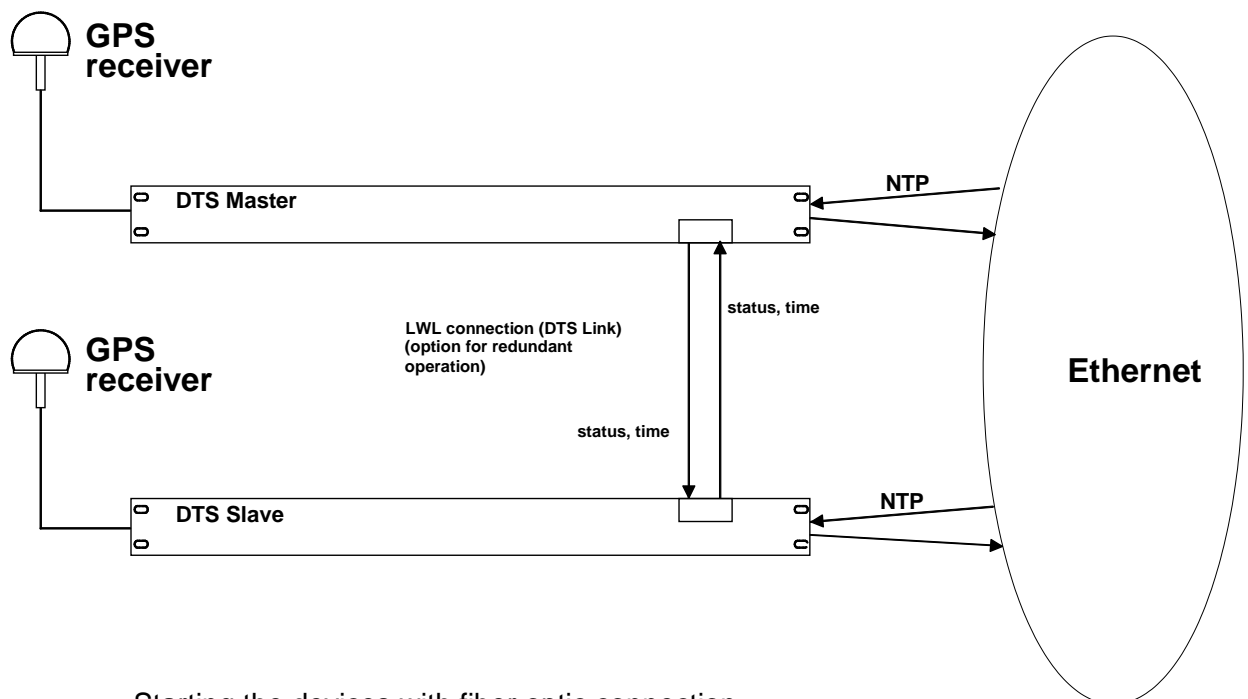

- Starting the devices with fiber optic connection
The devices work out among themselves which is the master (normally the one synchronized first)
- Starting the devices without fiber optic connection
The devices do not send out any time information until there is an LWL connection, or the devices are reconfigured.
- The slave synchronizes to the master.
Whereby $\text{stratum/slave} = \text{stratum/master} + 1$
The time of the slave is always set immediately to the master time (no fine adjustment).

- In case of loss of the master GPS, the master stratum increases on the basis of the configurable parameters up to the maximum stratum. The slave follows, i.e. the slave stratum is always 1 higher. The slave takes over the master role from a configurable stratum value (if the status of the slave is better than that of the master) and synchronizes to its own GPS. The previous master becomes the slave. This distribution of roles remains until the new master loses GPS synchronization.
- In the case of a loss of the master, the slave takes over the master function.
- If the former master is working again, it takes over the actual time of the current master and remains in slave mode.
- In the case of a fiber optic connection loss, the slave checks the status of the master over the network and remains in slave mode as long as the master is accessible and is working normally. If the master is no longer accessible or has a worse status, the slave takes over the master function.

NTP

The NTP clients select the server with the lower stratum.

DCF77 coded (fiber optic output)

No redundancy

2 LAN Mode

The two redundant DTS 4138 are not located in the same network. The role decision (master, slave) takes place exclusively via opt. link.

RTC:

RTC is to be deactivated for the redundant mode.

9.1 General

The SNMP version **V2c** or **V3** for *Get*, *Set* and version **V1** or **V2c** for *Notification* (Trap) is used.

A full SNMP agent is implemented on the DTS (MIB II, DTS4138).

For SNMP V2c, following standard *Communities* are used:

Read only : *romobotime*
Read/Write: *rwmobotime*
Trap: *trapmobotime*

For SNMP V3, following standard *User / Passwords* are used:

dtsUser1 *mobotime*
dtsUser2 *mobotime*
dtsInfo *mobotime* (*not changeable, read only*)

DtsUser1 and dtsUser2 have full read/write access on all objects. With SNMP V3 rules, access can be reduced. Changes of the rules can only be modified over the DTS menu but not via SNMP.

SNMP V3 agent supports user validation (authentication MD5) and encoding (encryption DES).

MIB II values like sysDescr, sysContact, sysName, or sysLocation can only be modified over the DTS menu but not via SNMP.

The following MIB definitions are used:

SNMPv2-SMI, SNMPv2-MIB, SNMPv2-CONF, SNMPv2-TC, SNMPv2-TM,
SNMP-FRAMEWORK-MIB, SNMP-MPD-MIB, SNMP-NOTIFICATION-MIB,
SNMP-TARGET-MIB, SNMP-USER-BASED-SM-MIB, SNMP-VIEW-BASED-ACM-MIB,
RFC1213-MIB, IF-MIB, IP-MIB, IP-FORWARD-MIB, TCP-MIB, UDP-MIB,
HOST-RESOURCES-MIB, HOST-RESOURCES-TYPES, DISMAN-EVENT-MIB,
NOTIFICATION-LOG-MIB, UCD-SNMP-MIB, NET-SNMP-MIB, NET-SNMP-TC

SNMP V2c, V3:

DTS-COMMON (File: DTS-COMMON-MIB.TXT)
 General DTS definition, always required
DTS4138 (DTS4138-MIB.TXT)
 Device-specific DTS definitions

The MIB files can be copied from the DTS 4138 with FTP (For FTP use, see chapter "7.7 FTP connection"):

DTS-MIB: */etc/snmp/mibs/*
Standard MIBS: */usr/share/snmp/mibs/*

9.2 Device configuration with SNMP

If one or several variables are set with *Put* in a configuration group, the variable *dts4138????ConfigCmd* must be set at the end to 1 in the corresponding group. The values of the entire configuration group are assumed from the DTS with this command (1=Save).

As long as the accept command has not been set, the changed variables can be restored to the old values by setting the *dts4138????ConfigCmd* variable to 2 (2=undo, restore).

After sending the accept command, a *dts4138ConfigChanged Notification* is sent.

The definitions of the available variables can be taken from the MIB files.

Example:

Management-System		DTS
<i>Put</i> dts4138FTPMODE=1	→	Variable is set to 1 internally
<i>Put</i> dts4138NetServicesConfigCmd=1	→	Configuration group is assumed
	←	Sends <i>dts4138ConfigChanged Notification</i> with the new time <i>dts4138NetConfigChangedTime</i>

9.3 DTS subagent SNMP notification

Protocol: SNMPv2c Notification

For *Notifications* to be sent out, SNMP must be switched on. In addition, at least one receiver system must be configured.

9.3.1 Startup

[dts4138StartUp]

Sent out when the subagent for the DTS is started.

This *Notification* is always sent out, as soon as SNMP is activated and a destination address is configured.

9.3.2 Shutdown

[dts4138Shutdown]

Sent out when the subagent for the DTS is stopped.

This *Notification* is always sent out, as soon as SNMP is activated and a destination address is configured.

9.3.3 Status changed

[dts4138StatusChanged]

Sent out when the subagent detects a status change in the DTS application process. The following variables are monitored for changes:

dts4138SysStatus, dts4138NTPTInfoCurrentSource, dts4138SysStratum

This *Notification* is always sent out, as soon as SNMP is activated, and a destination address is configured.

The *Notification* sent out contains the following data:

Field	Type	Size	Description	Example
dts4138SysStatus	Unsigned Int	4 Bytes	Contains the internal system status	66309
dts4138SysOffset	Integer	4 Bytes	Actual time offset of the system [us]	-1523 → -1.523ms
dts4138NTPTInfoCurrentSource	Byte String	63	Actual time source	192.168.1.55
dts4138SysStratum	Byte	1 Byte	Actual system stratum level	1

9.3.4 Configuration changed

[dts4138ConfigChanged]

Sent out when the subagent detects a configuration change in the DTS application processes.

This *Notification* is always sent out, as soon as SNMP is activated and a destination address is configured.

The *Notification* sent out contains the following data:

Field	Type	Size	Group
dts4138SysConfigChangedTime	TimeTicks	4 Bytes	dts4138System
dts4138NetworkIf0ConfigChangedTime	TimeTicks	4 Bytes	dts4138NetworkIf0
dts4138NetworkIf1ConfigChangedTime	TimeTicks	4 Bytes	dts4138NetworkIf1
dts4138NetConfigChangedTime	TimeTicks	4 Bytes	dts4138Network
dts4138NetServicesConfigChangedTime	TimeTicks	4 Bytes	dts4138NetServices
dts4138TSConfigChangedTime	TimeTicks	4 Bytes	dts4138TimeSource
dts4138RedOpConfigChangedTime	TimeTicks	4 Bytes	dts4138TimeRedundantOp
dts4138NTPConfigChangedTime	TimeTicks	4 Bytes	dts4138TimeNTPServer
dts4138OutMainDCFConfigChangedTime	TimeTicks	4 Bytes	dts4138OutMainDCF
dts4138OutLineDCFPulseFREQConfigChangedTime	TimeTicks	4 Bytes	dts4138OutLineDCFPulseFREQ
dts4138OutLineSerialConfigChangedTime	TimeTicks	4 Bytes	dts4138OutLineSerial
dts4138OutLineIRIGConfigChangedTime	TimeTicks	4 Bytes	dts4138OutLineIRIG
dts4138OutLineTZServerConfigChangedTime	TimeTicks	4 Bytes	dts4138OutLineTZServer
dts4138RelayConfigChangedTime	TimeTicks	4 Bytes	dts4138AlarmRelayConfig
dts4138MailConfigChangedTime	TimeTicks	4 Bytes	dts4138AlarmMailConfig
dts4138SnmpConfigChangedTime	TimeTicks	4 Bytes	dts4138SnmpConfig
dts4138SnmpV3ConfigChangedTime	TimeTicks	4 Bytes	dts4138SnmpV3

The *ConfigChangedTime* variables show the time of the last change of the relevant configuration group as TimeTicks value in 1/100th seconds. The management system can decide on the basis of these time values, which configurations need to be reloaded.

The groups and their parameters are listed in appendix "G Parameters".

9.3.5 Alive Notification

[dts4138Alive]

Sent out in a configurable interval.

This *Notification* is always sent out, as soon as SNMP and the alarm traps are activated and a destination address is configured.

The *Notification* sent out contains the following data:

Field	Type	Size	Description	Example
dts4138SysStatus	Unsigned Int	4 Bytes	Contains the internal system status	66309
dts4138SysAlarms	Byte Array	8 Bytes	64 Bit Alarm flags 1.Byte Bit 0..7 2.Byte Bit 8..15 :: 8.Byte Bit 56..63	FFF870FF.FFFFFFFF 5.Byte 2.Byte 1.Byte

9.3.6 Alarm Notification

[dts4138Alarm]

Sent out if alarm status changes, i.e. *Notification* is sent out when an alarm flag is set or deleted.

This *Notification* is always sent out, as soon as SNMP and the alarm traps are activated and a destination address is configured.

The *Notification* sent out contains the following data:

Field	Type	Size	Description	Example
dts4138TrapAlMsgErrorNr	Byte	1 Byte	No. of the alarm bit (0..63)	3
dts4138TrapAlMsgErrorState	Byte	1 Byte	0 = alarm bit was deleted 1 = alarm bit was set	1
dts4138TrapAlMsgErrorTime	Unsigned Int	4 Bytes	PC-time in seconds since 01.01.1970 00:00:00	946684805
dts4138TrapAlMsgErrorText	Text	59 Bytes	Error text	Failure supply 1

10 Power supply alternatives

The DTS 4138 permits 2 different power supply alternatives:

1. DC power supply with 24VDC +20% / -10% to "DC in 1" or "DC in 2"

Notice: In the menu: '2 Configuration' → '4 General' → '3 Power' must be set to '0=single'.

2. Redundant power supply:

Supply1: DC in 1 **Supply2:** DC in 2

Supply is checked once per minute for correct functioning. The alarm 'loss of power 1' or 'loss of power 2' is set in case of error.

Notice: In the menu: '2 Configuration' → '4 General' → '3 Power' must be set to '1=redundant'.

Block diagram of power supply:

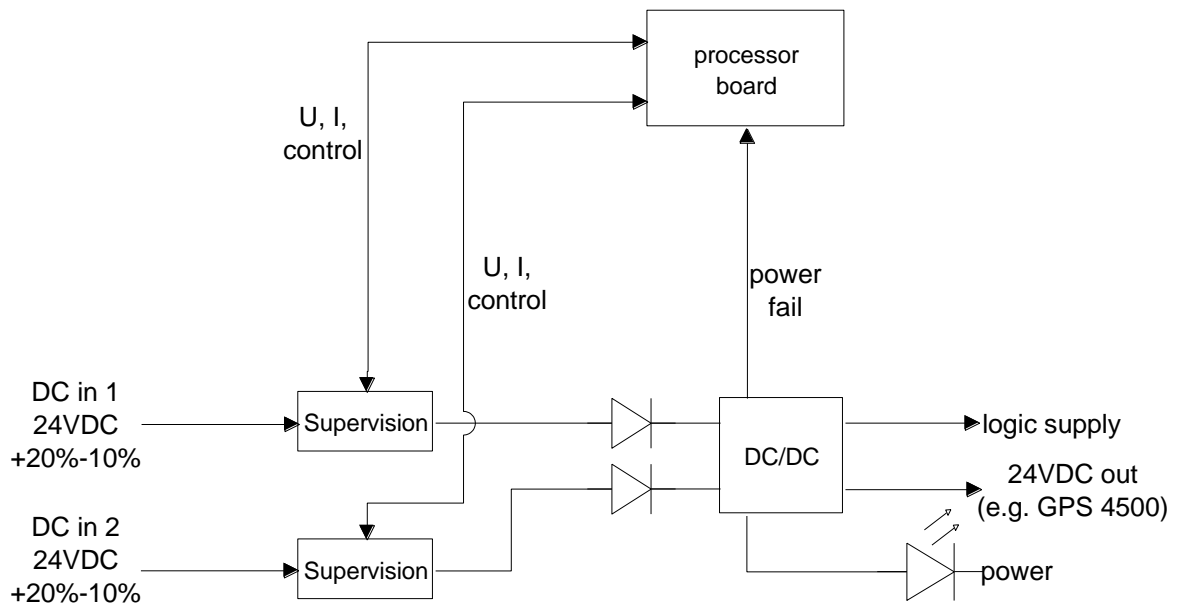

A Connection diagrams

A.1 Front connections

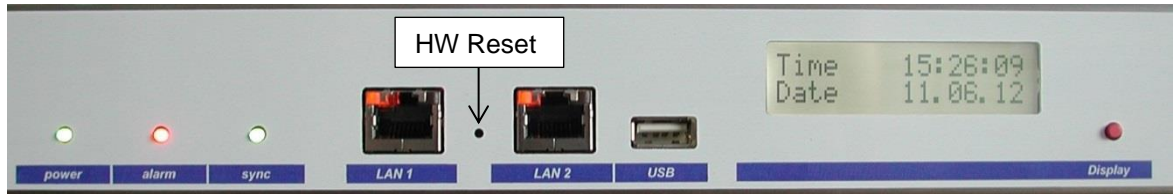

LAN 1 connection:

Plug: RJ45
Interface: Ethernet, 10/100Mbit half- or full duplex
Use only shielded cables!

LAN 2 connection:

Plug: RJ45
Interface: Ethernet, 10/100Mbit half- or full duplex
Use only shielded cables!



Notice: If only one LAN interface is used, it always has to be LAN 1!

USB connection:

Plug: USB host



Notice: Only permitted for operations with a USB stick!

A.2 Connections (rear view)

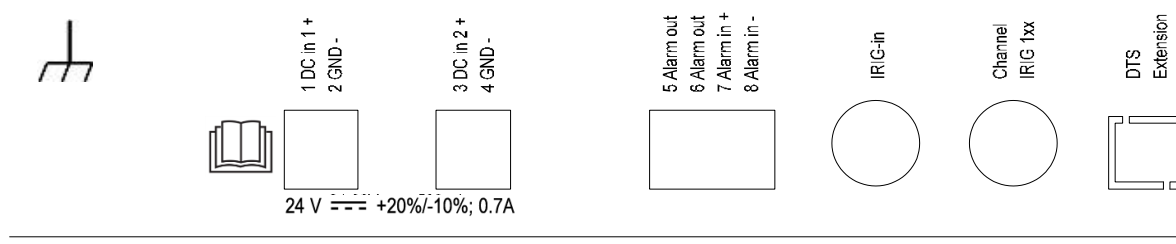

DTS 4138 connections

For technical data, see appendix "H Technical data".

Clamp	Connection	Description
	Earth connection	
1	DC in 1 power supply +	Input for external DC supply Ground
2	DC in 1 power supply GND	
3	DC in 2 power supply +	Input for external DC supply Ground
4	DC in 2 power supply GND	
5	Alarm relay	Alarm contact, open when alarm is active Switching load: 30 W (125 VDC or 1 A), e.g. 1 A @ 30 VDC or 60 VA (150 VAC or 1 A), e.g. 0.5 A @ 120 VAC
6	Alarm relay	
7	Common +	Alarm input (see drawing below): 18-36VDC, max. consumption 6mA DC, closing contact. Voltage level "high" (ext. 24V available, GND from PIN 11) or external contact → configurable: alarm or no alarm. Length of connection max. 3m.
8	Alarm input +	
IRIG-In	BNC	AFNOR-A/C, IRIG-B12x synchronization input
IRIG 12x Channel 1	BNC: IRIG-B12x output	AFNOR-A/C, IRIG-B1xx and DCF-FSK output for IRIG line 1
DTS extension	DTS extension	DTS extension bus

Alarm Input:

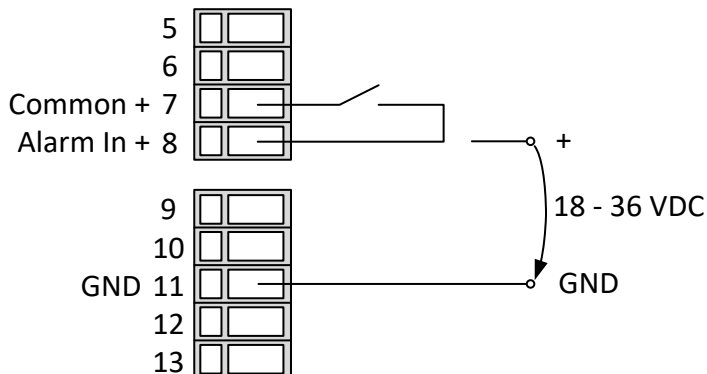

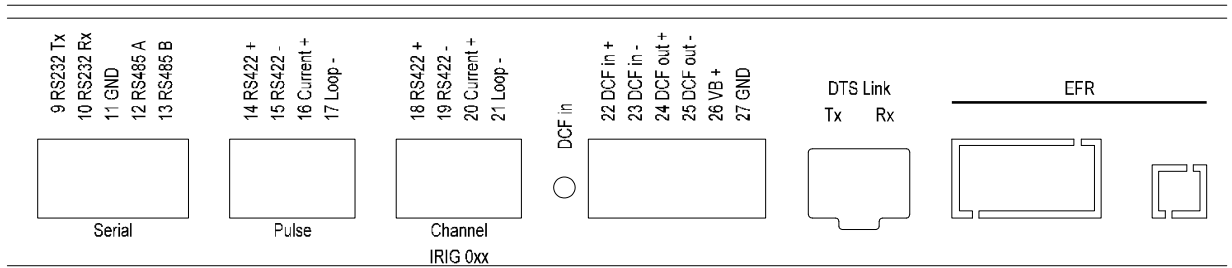

Clamp	Connection	Description
9	RS232 Tx	RS232 interface of line 1 (Exclusive to the RS485 interface line 1; internally the same interface)
10	RS232 Rx	
11	GND	
12	RS485 A	RS485 interface of line 1 (Exclusive to the RS232 interface line 1; internally the same interface)
13	RS485 B	
14	RS422 + Pulse 1	RS422 output line 1 for DCF, pulse and frequency output (internally the same source of signal like for the current loop output)
15	RS422 – Pulse 1	
16	CL + Pulse 1	Current loop line 1 for DCF, pulse and frequency output ("Current loop" passive, optocoupler: $U_{max} = 50VDC$, $I_{max} = 10mA$)
17	CL – Pulse 1	
18	RS422 +	Digital IRIG-B signal (00x) of the IRIG line 1
19	RS422 –	
20	Current Loop +	Digital IRIG-B signal (00x) of the IRIG line 1 as current loop ("current loop" passive, optocoupler: $U_{max} = 50VDC$, $I_{max} = 10mA$)
21	Current Loop –	
22	DCF input +	DCF input e.g. for the connection of a GPS 4500 or DCF receiver with "current loop" output.
23	DCF input -	
24	DCF output +	DCF output, "current loop" passive, $U_{max} = 30VDC$, $I_{on} = 10..15mA$, $I_{off} < 1mA @ 20VDC$
25	DCF output -	
26	DC output +	DC output for GPS 4500 28 VDC, max. 200 mA
27	DC output GND	
	DTS-Link	Optical connection to a 2nd DTS 4138 Mini GBIC plug-in
	EFR	Option, for special applications only

A.3 Plug-in spring terminals

Multiple contact strip 100% protected against wrong plug;
 WAGO CAGE CLAMP®-connection
 Cross section of 0,08 mm² to 1,5 mm² (from AWG 28 to AWG 14)
 Voltage CSA 300 V / current CSA 10 A
 Rated voltage: EN 250 V
 Rated surge voltage: 2,5 kV
 Nominal current: 10 A
 Strip length: 7 mm (0,28 in)



Pulled off spring terminal with operation tool:

2 operation tools are delivered with the accessory bag.

A.4 Connection GPS / GNSS 4500, DCF 4500 or GNSS 3000

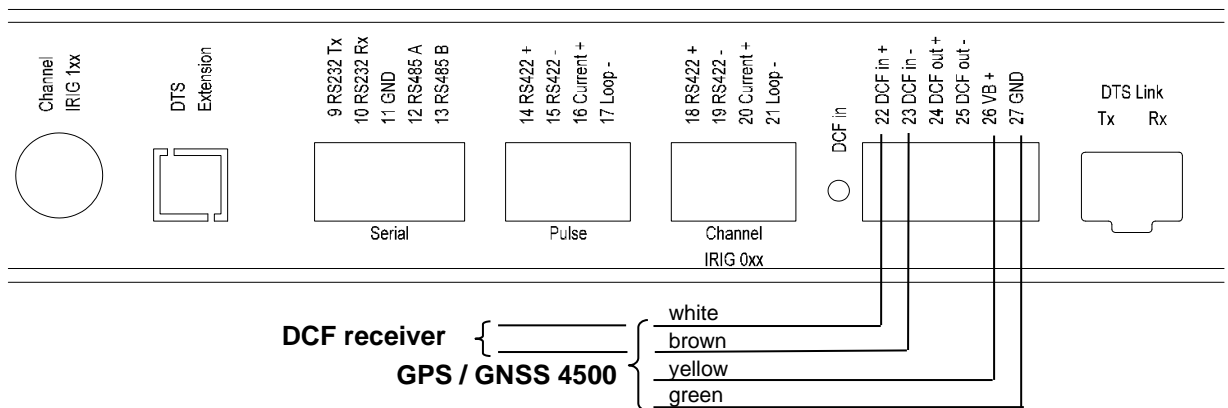

GNSS 3000 according to manual Bx-800813 chap. 9.2 Connection schematics DCF current loop

A.5 IRIG-B00x Digital Output TTL connection

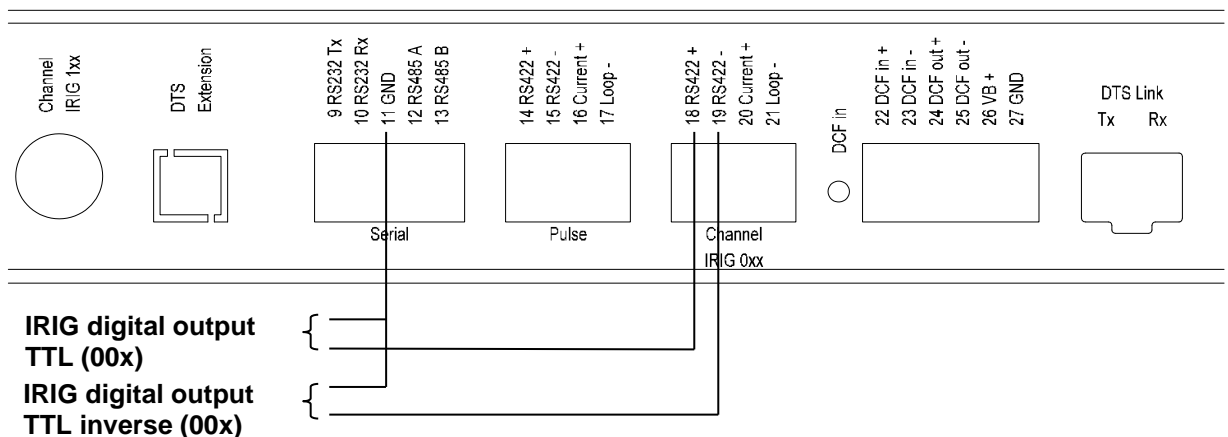

B Time zone table

Time zone entries in the standard season table (version 10.3).

No.	City / State	UTC Offset	DST	Standard → DST	DST → Standard
00	UTC (GMT), Monrovia	0	No		
01	London, Dublin, Lisbon	0	Yes	Last Sun. Mar. (01:00)	Last Sun. Oct. (02:00)
02	Brussels, Amsterdam, Berlin, Bern, Copenhagen, Madrid, Oslo, Paris, Rome, Stockholm, Vienna, Belgrade, Bratislava, Budapest, Ljubljana, Prague, Sarajevo, Warsaw, Zagreb	+1	Yes	Last Sun. Mar. (02:00)	Last Sun. Oct. (03:00)
03	Athens, Helsinki, Riga, Tallinn, Sofia, Vilnius	+2	Yes	Last Sun. Mar. (03:00)	Last Sun. Oct. (04:00)
04	Bucharest	+2	Yes	Last Sun. Mar. (03:00)	Last Sun. Oct. (04:00)
05	Pretoria, Harare, Kaliningrad	+2	No		
06	Amman	+2	Yes	Last Thu. Mar. (23:59)	Last Fri. Oct. (01:00)
07	UTC (GMT)	0	No		
08	Istanbul, Kuwait City, Minsk, Moscow, Saint Petersburg, Volgograd	+3	No		
09	Praia, Cape Verde	-1	No		
10	UTC (GMT)	0	No		
11	Abu Dhabi, Muscat, Tbilisi, Samara	+4	No		
12	Kabul	+4.5	No		
13	Adamstown (Pitcairn Is.)	-8	No		
14	Tashkent, Islamabad, Karachi, Yekaterinburg	+5	No		
15	Mumbai, Kolkata, Chennai, New Delhi, Colombo	+5.5	No		
16	Astana, Thimphu, Dhaka, Novosibirsk	+6	No		
17	Bangkok, Hanoi, Jakarta, Krasnoyarsk	+7	No		
18	Beijing, Hong Kong, Singapore, Taipei, Irkutsk	+8	No		
19	Tokyo, Seoul, Yakutsk	+9	No		
20	Gambier Island	-9	No		
21	South Australia: Adelaide	+9.5	Yes	1 st Sun. Oct (02:00)	1 st Sun. Apr. (03:00)
22	Northern Territory: Darwin	+9.5	No		
23	Brisbane, Guam, Port Moresby, Vladivostok	+10	No		
24	Sydney, Canberra, Melbourne, Tasmania: Hobart	+10	Yes	1 st Sun. Oct. (02:00)	1 st Sun. Apr. (03:00)
25	UTC (GMT)	0	No		
26	UTC (GMT)	0	No		
27	Honiara (Solomon Is.), Magadan, Noumea (New Caledonia)	+11	No		
28	Auckland, Wellington	+12	Yes	Last Sun. Sep. (02:00)	1 st Sun. Apr. (03:00)
29	Majuro (Marshall Is.), Anadyr	+12	No		
30	Azores	-1	Yes	Last Sun. Mar. (00:00)	Last Sun. Oct. (01:00)
31	Middle Atlantic	-2	No		
32	Not used				
33	Brasilia, Buenos Aires	-3	No		
34	Newfoundland	-3.5	Yes	2 nd Sun. Mar. (02:00)	1 st Sun. Nov. (02:00)
35	Atlantic Time (Canada)	-4	Yes	2 nd Sun. Mar. (02:00)	1 st Sun. Nov. (02:00)
36	La Paz	-4	No		
37	Bogota, Lima, Quito	-5	No		
38	New York, Eastern Time (US & Canada)	-5	Yes	2 nd Sun. Mar. (02:00)	1 st Sun. Nov. (02:00)
39	Chicago, Central Time (US & Canada)	-6	Yes	2 nd Sun. Mar. (02:00)	1 st Sun. Nov. (02:00)

40	Tegucigalpa, Honduras	-6	No		
41	Phoenix, Arizona	-7	No		
42	Denver, Mountain Time	-7	Yes	2 nd Sun. Mar. (02:00)	1 st Sun. Nov. (02:00)
43	Los Angeles, Pacific Time	-8	Yes	2 nd Sun. Mar. (02:00)	1 st Sun. Nov. (02:00)
44	Anchorage, Alaska (US)	-9	Yes	2 nd Sun. Mar. (02:00)	1 st Sun. Nov. (02:00)
45	Honolulu, Hawaii (US)	-10	No		
46	Midway Islands (US)	-11	No		
47	Mexico City, Mexico	-6	Yes	1 st Sun. Apr. (02:00)	Last Sun. Oct. (02:00)
48	Adak (Aleutian Is.)	-10	Yes	2 nd Sun. Mar. (02:00)	1 st Sun. Nov. (02:00)
49	UTC (GMT)	0	No		
50	UTC (GMT)	0	No		
51	UTC (GMT)	0	No		
52	UTC (GMT)	0	No		
53	UTC (GMT)	0	No		
54	Ittoqqortoormiit, Greenland	-1	Yes	Last Sun. Mar. (00:00)	Last Sun. Oct. (01:00)
55	Nuuk, Qaanaaq, Greenland	-3	Yes	Last Sat. Mar. (22:00)	Last Sat. Oct. (23:00)
56	Not used				
57	Western Australia: Perth	+8	No		
58	Caracas	-4.5	No		
59	CET standard time	+1	No		
60	Not used				
61	Not used				
62	Baku	+4	Yes	Last Sun. Mar. (04:00)	Last Sun. Oct. (05:00)
63	UTC (GMT)	0	No		
64	UTC (GMT)	0	No		

In countries where the DST switch date changes annually (e.g. Iran, Israel), the time zone has to be defined manually in the user time zone table (entries 80 – 99).

Legend:

UTC: Universal Time Coordinate, equivalent to GMT
DST: Daylight Saving Time
DST Change: Daylight Saving Time changeover
Standard → DST: Time change from Standard time (Winter time) to Summer time
DST → Standard: Time change from Summer time to Standard time (Winter time)

Example:

2nd last Sun. Mar. (02:00) Switch over on the penultimate Sunday in March at 02.00 hours local time.



Important:

The Time Zone Table is usually updated as needed. The current table is available for download under the following address: www.mobatime.com → Customer Area → Customer Support → Support Resources → Time Zone Table. In case your device is equipped with a newer version than shown in this manual, the current time zone settings should be checked.

Modifications / updating the time zone table:

In the DTS device the time zone tables are stored in the files */etc/mbsn.tbl* (standard table) and */etc/usersn.tbl* (user table).

The user table can be changed with Moser-Baer AG software such as ETCW or MOBA-NMS. Using MOBA-NMS, it can be downloaded from there, otherwise, it must be copied on to the DTS 4138 in accordance with the update instructions (chapter “7.4 Updating applications or configurations with FTP”).



Notice:

The file names *mbsn.tbl* and *usersn.tbl* must be written in small letters.

C Alarm list

Number	Error message	Description / Action	Chap.
0	Reboot DTS	DTS 4138 restarted, no intervention required	
1	Error bit1	Not used	
2	Supply voltage too low	Power failure (internally measured) → support	
3	Power failure 1	Power failure 1 (only if redundant supply is on)	
4	Power failure 2	Power failure 2 (only if redundant supply is on)	
5	Error voltage 5V	Power failure (internally measured) → support	
6	Error voltage 2.5V	Power failure (internally measured) → support	
7	Error voltage 1.25V	Power failure (internally measured) → support	
8	Wrong time zone DCF	Check DCF configuration	6.5.2
9	Wrong time zone TC	Check TC configuration (IRIG/DCF/Impulse)	6.5.3 / 5
10	Error bit10	Not used	
11	Alarm input	Error from external device	6.5.18
12	Low voltage IRIG	Low voltage on analogue AFNOR/IRIG-B output	6.5.5
13	Error bit13	Not used	
14	Error bit14	Not used	
15	Error bit15	Not used	
16	Time source lost	Stratum too high: check time source	6.5.8
17	Failure time source TO	No time information from the selected time source within the configured timeout: Check time source. In slave mode: check link.	6.5.8
18	No valid time	20 min after starting no valid time → Check time source	
19	NTP synch. lost	Check NTP source	
20	Software trimming	Quartz error or poor source quality	
21	NTP not working	Check NTP configuration	
22	NTP backup active	Check primary source	
23	Syn only diff too large	Check synchronization and source	6.5.9
24	No mail server	Check e-mail configuration, check connection	6.5.16
25	SNMP not running	Check SNMP and trap configuration	6.5.17
26	Error bit26	Not used	
27	Error bit27	Not used	
28	Error bit28	Not used	
29	Error bit29	Not used	
30	No link (optical)	No connection via DTS link (optical link) in redundant operation. Check connection.	
31	No link (LAN)	No connection via LAN link in redundant operation. Check LAN connection.	
32	Change Slave->Master	Switch over slave -> master has occurred. Optionally, check the time source of current slave.	
33	Offset source (slave)	In slave mode only: check time sources Difference between slave and local time source too large	6.5.10
34	Fail local source	In slave mode only: check time sources	6.5.8
35	Error bit35	Not used	

36	Error bit36	Not used	
37	Error bit37	Not used	
38	Tele.-file invalid	Check telegram file: the file name is longer than 8 digits or the file type is not TEL, Tel or tel; alternatively, syntax error in telegram file	6.5.4
39	Wrong time zone serial	Check serial time zone configuration	6.5.4
40	Error bit40	Not used	
41	Error bit41	Not used	
42	Error bit42	Not used	
43	Error bit43	Not used	
44	Error bit44	Not used	
45	Error bit45	Not used	
46	Error bit46	Not used	
47	Error bit47	Not used	
48	Error bit48	Not used	
49	Error bit49	Not used	
50	Error bit50	Not used	
51	Error bit51	Not used	
52	Error bit52	Not used	
53	Error bit53	Not used	
54	Error bit54	Not used	
55	Error bit55	Not used	
56	Error bit56	Not used	
57	Error bit57	Not used	
58	Error bit58	Not used	
59	Error bit59	Not used	
60	Error bit60	Not used	
61	Error bit61	Not used	
62	Error bit62	Not used	
63	Error bit63	Not used	

D Troubleshooting

	Error	→	→	Solution / possible cause
1	DTS does not accept time	Does the reading change (approx. every 3 sec) <i>Sec counter DCF</i> in <i>Status</i> → <i>Source</i> → TIME SOURCE INFORMATION?	No, but 20 min. have not yet passed since the last reboot.	After new installation or powers supply failure, it may take up to 20 min. until the GPS receiver (e.g. GPS 4500) sends out valid telegrams. Wait for this time to pass.
2			No, for more than 20 minutes.	<ul style="list-style-type: none"> • Check DCF reception LED • Check polarity cabling to GPS. • Check positioning of the GPS receiver
3		Error-Bit 23 (<i>Syn only diff too big</i>) in <i>Status</i> → <i>Alarm status</i> set		The deviation to the received time is beyond the maximal allowed time correction. In the menu <i>Configuration</i> → <i>Time administration</i> → <i>Time-keeping configuration</i> → TIME ADJUSTMENT CONFIGURATION, set the parameter <i>synch. only offset</i> (4) to 0 (=deactivated). The time is now adjusted independently of the deviation's extend. It is however recommended to set a limit in normal operation (default 800ms).
4		<i>Offset to source</i> in <i>Status</i> → <i>Time</i> → TIME INFORMATION AND STATUS always shows the same offset		<ul style="list-style-type: none"> • If Error-Bit 23 set, see point 3 • The deviation is that big, that offset changes cannot be seen due to the displayed resolution.
5		Configuration has just been changed		In the case of configuration changes, particularly if the time configuration is concerned, it can take several minutes for the change to appear correctly.
6	Error-Bit 16 set (<i>time source fail stratum</i>)			See 1
7	Error-Bit 17 set (<i>time source fail TO</i>)			See 1
8	Error-Bit 23 set (<i>Syn only diff too big</i>)			See 1
9	DTS 4138 is restarting continuously.			Check if the network settings are correct, especially the hostname and the gateway has to be configured (when no gateway is available, the own IP address can be used).
10	LAN LED (left one) is flashing orange.	No connection to the network.		Check network cabling.
11	Opening the menu via Telnet is not possible or DTS 4138. timeserver is not or no longer reachable via network.			Check network settings in menu 2 Configuration → 5 Network (only possible with serial connection): <ul style="list-style-type: none"> - IP-Address, Subnet mask and Gateway must be set correctly - Interface should be set to Auto - Check connection with "Ping" - When earlier the menu was not correctly exited (e.g. LAN cable removed), the menu can be blocked up to 15 minutes.
12	Drift (ppm) of quartz too high	The drift displayed in the menu <i>Status</i> → <i>Time</i> → TIME INFORMATION AND STATUS is bigger than stated in the data sheet.		<ul style="list-style-type: none"> • The quartz drift is measured and corrected continuously. After initial operation, it may take up to 24 hours until optimal accuracy is reached (with GPS reception). • Very large temperature change (outside the specification) • Time correction was carried out manually.
13	System software update			The system software can be updated using FTP client software or a USB stick (s. chapter 7 Updates). Your MOBATIME service informs you of use and necessity of a software update. If necessary, they can provide the needed firmware file.

14	<p>Needed information to contact your MOBATIME service</p>		<p>Device type, part number, production number and serial number: These details are given on the adhesive type label.</p> <p>The following files must be provided for the analysis: All files (in .zip folders, separate for each device) from the directories <i>/var/log/</i> and <i>/etc/</i> and the file: <i>/ram/trim.log</i>. To copy this files use FTP, e.g. Windows Explorer with ftp://[IP address], see chapter 7.7.</p> <p>If the log files cannot be copied, please read out the current software version: The software version can be queried in the menu 1 STATUS/9 Versions of the software</p> <p>Place and date of purchase and of commissioning of the device.</p> <p>Most comprehensive possible details of the malfunction: Describe the problem, possible causes, measures taken, the system environment / operating mode and configuration, etc.</p>
----	--	--	--

E Serial Telegrams

E.1 General

A serial interface can be used in two different modes:

- Send out time of telegrams automatically (periodically)
- Receive command, send time telegram (on request)

Output modes

Auto Periodic transmission of a time telegram or a command at the end of a second, minute, hour, or at a max. of 6 programmable times of the day, or definable output – periodicity.

on request Telegram is transmitted on request. The 'request' strings can be defined.

The following requests are possible:

- stop output
- output telegram at once (singly)
- output telegram at the next second (singly)
- output every second / minute / hourly / daily or switch to auto-mode.

Telegram format

Any character sequence. Fill characters ASCII or binary.

Variable display: ASCII decimal, ASCII hexadecimal or binary. Different variables are assigned to strings in text tables (e.g. month: Jan, Feb...). Syntax for the telegram string analogous to the print command in the programming language "C". See chapter E.2 Syntax of the telegram configuration file.

Telegram time

The telegram always contains the time information for the "next" second for periodical telegram output. The telegram content is valid at the send time of the first character. The send time of the telegram can be shifted with the parameter TC (e.g. the standard IF 482 telegram valid at the end of the telegram).

The transmission time of a time telegram can be calculated with the following table. According to the transmission format set, the transmission time in ms for one character is read from the table and multiplied by the number of telegram characters:

parity stopp byte	7 data bits				8 data bits				
	none		odd/even		none		odd/even		
	1	2	1	2	1	2	1	2	
ms per transmited byte									
300	bit/s	30.00	33.33	33.33	36.67	33.33	36.67	36.67	40.00
600	bit/s	15.00	16.67	16.67	18.33	16.67	18.33	18.33	20.00
1200	bit/s	7.50	8.33	8.33	9.17	8.33	9.17	9.17	10.00
2400	bit/s	3.75	4.17	4.17	4.58	4.17	4.58	4.58	5.00
4800	bit/s	1.88	2.08	2.08	2.29	2.08	2.29	2.29	2.50
9600	bit/s	0.94	1.04	1.04	1.15	1.04	1.15	1.15	1.25
19200	bit/s	0.47	0.52	0.52	0.57	0.52	0.57	0.57	0.63
38400	bit/s	0.23	0.26	0.26	0.29	0.26	0.29	0.29	0.31

Example:

9600 Bit/s, 8 data bits, none, 1 stop bit, the telegram has 20 characters.

Transmission time for the entire telegram:

20 x 1.04 ms = 20.8 ms

Name of the telegram file

The telegram file name is limited to 8 characters and its extension has to be TEL, Tel or tel, e.g. IF482Std.tel.

E.2 Syntax of the telegram configuration file

```
!TEL
    ;telegram type also !CTC or !MTS possible
;-- Start of the file (always on the first line) -----

;DEFINITIONS CONFIGURATION FILE FOR PRECISION MASTER CLOCK
;*****

;Customer:
;Date:
;Author:
;File:
;Interface:

;-- Output string -----
; the output string has a similar format to the print command in the
; programming language 'C'.
; !TS! - String with format information
; !TV! - Variables list in output sequence
; The formats and variables available can be seen below:
;
!TS!".....%d....%d..." ;String with Format information
!TV!var1,var2,..         ;Variables list

;-- Control and special characters
; " -> String beginning/end
; \" -> "
; \xFE -> h'FE (Byte binary)
; \\ -> \
; \n -> new line <CR> <LF> (h'0D h'0A)
; %% -> %
; %... -> Format information (see below)

;-- Possible formats:
;%dn ascii-dez where n=1/2/3/4 (number of decimal points, max. 3 places received)
; e.g. variable value d'40 => 40 @ n=2
; => 040 @ n=3
;%X ascii-hex
; e.g. variable value d'40 => 28
;%c char (binary)
; e.g. variable value d'40 => h'28
;%s string (always up to,(comma) see text tables
; e.g. string Jan, => Jan
;%b hex-output of an asciihex-string (always up to(comma)see
; text tables
; e.g. string 120A, => h'12 h'0A

;-- Possible variables:
;
;Name: Description: Range: Format:
;-----|-----|-----|-----
;
;MSE (Millisecond) (0..999) 1W
;HSE (Hundredth of a second) (0..99) 1B
;ZSE (Tenth of a second) (0..9) 1B
;SEK (Second) (0..59) 1B
;MIN (Minute) (0..59) 1B
;STD (12h or 24h format) (0..12)
; or(0..24) 1B (see !PM!)
;JAR (Year) (0..99) 1W
; or (1990..2089)
```

```

;MTG (Day of the month) (1..31) 1B
;JTG (Day of the year) (1..366) 1W
;WTG (Day of the week) (0..6) 1W Text table !WT!
; (Su..Sa)
;DOW (Day of the week) (0..7) 1B !DW!
;KAW (Calendar week) (1..53) 1B (according to Din ISO 8601)
;MON (Month) (1..12) 1W Text table !MO!
;MNT (Month) (1..12) 1B
;
;AMF (am/pm flag) (0/1) 1W Text table !AM!
;TMQ (synchronization qual.) (0..255
; or A..Z) 1B (see !TQ!)
;SAI (Season) (0..2) 1W Text table !SA!
; (Win/Sum/UTC)
;AKS (Season change (0/1) 1W Text table !AK!
; announcement)
;AMF (am/pm-Flag) (0/1) 1W Text table !AM!
;SST (Season status) (0..3) 1W Text table !ST!
; (Bit 0 = Early warning bit)
; (Bit 1 = Summer bit)
;SYA (Synch. alarm) (0/1) 1W Texttable !SY!
; (0:synch ok, 1: synch alarm -> Alarm Nr.16, 17 or 19)
;CHS (Check sum) (0..255) 1B
;XCH (XOR Check sum) (0..255) 1B
;X1C (XOR Check sum low nibble in ASCII) (0..9, A..F) 1B
;X2C (XOR Check sum high nibble in ASCII) (0..9, A..F) 1B
; Definitions:
; CHS = (Sum of all bytes up to CHS) AND h'FF
; XCH = XOR link of all bytes up to CHS

;e.g. time telegram with following format (36 ASCII characters)
;
; "Date: tt:mm:yy Time: hh:mm:ss,mmm<CR><LF>"
;
; !TS!"Date: %d2:%s:%d2 time: %d2:%d2:%d2,%d3\n"
; !TV!MTG,MON,JAR,STD,MIN,SEK,MSE
;-----

;-- Send offset automatic telegram output -----
!SO!hh:mm:ss!
;
;Send offset from midnight 00:00:00 at periodic time
;output (!CS!a!...).
;
;hh = hour ('00..23')
;mm = minute ('00..59')
;ss = second ('00..59')
;
;e.g. the periodic time output should start at 06:00:00
; in each case:
;
; !SO!06:00:00!
;-----

;-- Interval automatic telegram output -----
!TI!p!hh:mm:ss!
;
;Interval from send offset of the periodic time output.
;
;s = every second
;m = every minute
;h = hourly
;d!hh:mm:ss! daily (max. 6 entries)
;p!hh:mm:ss! constant
;hh = hour ('00..23')
;mm = minute ('00..59')
;ss = second ('00..59')
;
;e.g.1 telegram output every second
; !TI!s!
;
;e.g.2 telegram output daily at 13:00:00 hours
; !TI!d!13:00:00!
;
;e.g.3: the interval of the periodic time output should be 5 seconds:
; !TI!p!00:00:05!
;-----

```

```

;-- Hours format -----
!PM!
    ;Hours format 12h with am/pm flag
    ;without this entry: 24h format
;-----

;-- Synchronization mode -----
!TC!mmm!
    ;Pretiming of the telegram in ms (-90..249). To synchronize the telegram
    ;end with the second start the TC has to be set according to the telegram
    ;length and the transmission format. If TC is set, it will be performed.
    ;
    ;e.g. Telegram start 120ms before the start of the second:
    ;     !TC!120!
;-----

;-- Format time quality -----
!TQ!MAX VALUE!STEP!
    ;If this entry is absent, the byte value of TMQ is
    ;outputted
    ;MAX VALUE corresponds to the byte value for A
    ;MAX VALUE-STAGE corresponds to the byte value for B
    ;MAX VALUE-2*STAGE corresponds to the byte value for C ...

    ;Example: A for values >=120..101
    ;          B for values =100..81
    ;          C for values = 80..61 ...
    ;
    ;          !TQ!120!20!
;-----

;-- Command Strings -----
!CS!n!l!"ss..."! or !CS!n!l!"ss..."!
;
; n = Number of the command ('2...9')
;     n=2 Quit (no telegram output)
;     n=3 Telegram output immediately(singly)
;     n=4 Telegram output at the next second(singly)
;     n=5 Telegram every second
;     n=6 Telegram every minute
;     n=7 Telegram hourly
;     n=8 Telegram daily (-> entry: !TI!d!xx..)
;     n=9 Output command (Request for external time source)
;     n=a Telegram output periodic according to !TI!p! and !SO!
;
; l or ll = Command length in bytes ('01...20')
;         l=0 Command not active
;
; ss... Command string
;         (max. 20 characters - must conform with 'l' or 'll')
;         Wildcards can be set with the '?' sign.
;         This serves as wildcard for any character.
;         Characters can also be outputted in AsciiHex format:
;         e.g.  \xFE    d.h <FE>=(h'FE) is inserted
;              \\      d.h '\ ' is inserted

;e.g. Definition of a commando for immediate telegram
;       output after a request (command n=3) :
;       'time<CR>' (characters ll=05)
;       !CS!3!05!"time?"!
;       !CS!3!5!"time\x0D"!
;-----

;-- Area for check sum calculation-----
!CK!aa,bb!
    ;aa = first character considered (telegram start position: 0)
    ;bb = last character considered + 1

;Missing !CK! in this case the check sum is formed via the whole telegram up to the
;check sum position.
;-----

```

```

;=====
;General info about the text tables:
; Name of the table: !xx!
; Separating character of the entries: , (comma)
; Maximal 16 characters pro Entry
; Warning: , do not forget (comma) after the last entry!
;=====

;-- Text table day of the week (WTG Su..Sa) 7 entries -----
!WT!Sunday,Monday,Tuesday,Wednesday,Thursday,Friday,Saturday,
;-----

;-- Weekday modus 1 entry -----
!DW!0..3
; 0 : 0 = Sunday, 1 = Monday,... 6 = Saturday
; 1 : 1 = Sunday, 2 = Monday,... 7 = Saturday
; 2 : 6 = Sunday, 0 = Monday,... 5 = Saturday
; 3 : 7 = Sunday, 1 = Monday,... 6 = Saturday
;-----

;-- Text table months (Jan..Dec) 12 entries -----
!MO!Jan, Feb, Mar, Apr, May, Jun, Jul, Aug, Sep, Oct, Nov, Dec,
;-----

;-- Text table season (Win, Sum, UTC) 3 entries -----
!SA!Win, Som, UTC,
;-----

;-- Text table season change announcement -----
;-- (no announcement, announcement) 2 entries
!AK!0,1,
;-----

;-- Text table season status -----
;-- (0 = no announcement, winter
;-- 1 = announcement, winter
;-- 2 = no announcement, summer
;-- 3 = announcement, summer) 4 entries
!ST!A,B,C,D,
;-----

;-- Text table AM/PM flag 2 entries -----
!AM!am,pm,
; 1.Entry AM/PM flag=0 d.h. 00:00..11:59
; 2.Entry AM/PM flag=1 d.h. 12:00..23:59
;-----

;-- Text table synchronization alarm 2 entries -----
!SY!ok,alarm,
; 1.Entry synchronization ok
; 2.Entry synchronization s-failure
;-----

;-- File End ---
!EE!

;-- Name of the file (optional) ----
@nnn...
; nnn... File name, maximum 12 characters and a final
; <CR>. The name can also be omitted, in this
; case CTC 'NONAMEX.TEL' appears in the directory.
;
; IMPORTANT:
; 1) The name must stand AFTER the file end!EE!.
;
; 2) If a file with the same name is loaded on to the
; CTC, such as one stored on the CTC, the stored one
; will be OVERWRITTEN.
;
;
; e.g. !EE!
; @TELEDEF.TEL
; ;last line
;-----

;last line (guarantees a <CR> after the file name)

```

F Copyright Notice

All rights of the software remain the property of Moser-Baer AG.

Existing software (OpenSource) with their own licences were partly used:

Designation	Description	Version	License	License Description (file)
U-Boot	Boot loader	2009.08	GPL version 2	COPYING
Linux	Operating system	3.2.0-rc3	GPL version 2	COPYING
Busybox	System environment	1.31.1	GPL version 2	LICENSE
NTP	NTP	4.2.8p14	Free	COPYRIGHT
pure-ftp	FTP server	1.0.49	Free, partly BSD	COPYING
NetSNMP	SNMP agent	5.8	BSD	COPYING
OpenSSL	SSL Lib.	1.1.1a	BSD style	LICENSE
OpenSSH	SFTP server	7.9p1	BSD	LICENCE
dropbear	SSH server	2018.76	MIT style: Free, party BSD	LICENSE
wide-dhcpv6	DHCPv6 client	20080615	Free	COPYRIGHT
flex	Flex Lib.	2.5.35	BSD adapted	COPYING
zlib	Compress lib.	1.2.5	Free	README
mailsend	E-mail client	1.15b5	GPL	-

The complete license descriptions can be referred to in the file indicated in the respective original source code on the corresponding project page.

Licence text GPL, BSD and MIT:

GPL version 2: <http://www.gnu.org/licenses/gpl-2.0.html>

BSD: <http://www.opensource.org/licenses/bsd-license.php>

MIT <http://www.opensource.org/licenses/with-license.php>

The source code of the open source projects running under GPL can be requested from Moser-Baer AG (support@mobatime.com). Handling costs will be charged!

G Parameters

Group	Parameter	Acc	Default	Unit	SNMP
Network	2 * Network				dts4138Network (generally) dts4138Network1 (LAN 1) dts4138Network2 (LAN 2)
	DHCP on/off	RW	LAN 1: on LAN 2: off		dts4138DHCPMode
	IP address	RW	LAN 1: dhcp LAN 2: 192.168.1.5		dts4138IPAddr
	Network mask	RW	LAN 1: dhcp LAN 2: 255.255.255.0		dts4138IPMask
	Gateway IP	RW	LAN 1: dhcp LAN 2: 192.168.1.1		dts4138IPGateway
	Name server IP	RW	LAN 1: dhcp LAN 2:		dts4138IPNameserver
	Autoconf V6	RW	off		dts4138IPv6AutoConf
	DHCPv6	RW	off		dts4138IPv6DHCPMode
	IP address V6 1	RW	0::0		dts4138IPv6Addr1
	IP prefix 1	RW	64		dts4138IPv6Prefix1
	Gateway IPV6 1	RW	0::0		dts4138IPv6Gateway1
	IP address V6 2	RW	0::0		dts4138IPv6Addr2
	IP prefix 2	RW	64		dts4138IPv6Prefix2
	Gateway IPV6 2	RW	0::0		dts4138IPv6Gateway2
	Name server IPV6	RW	0::0		dts4138IPv6Nameserver
	Link 10/100Mbit	RW	auto		dts4138EthernetLinkMode
	Device name / Host name	RW	DTS4138		dts4138Hostname, dts4138NetInfoHostname
	Domain	RW			dts4138Domain
Network Services					dts4138NetServices
	Telnet	RW	off		dts4138TelnetMode
	SSH	RW	on		dts4138SSHMode
	FTP	RW	off		dts4138FTPMode
General					dts4138System
	Display language	RW	engl.		dts4138Language
	Password user <i>dts</i>	RW	dts		dts4138Password
	Time zone operation and alarm messages	RW	MEZ		dts4138Timezone
	Redundant power supply	RW	off		dts4138PowerSupply
Lines					dts4138OutputLines
DCF out					dts4138OutMainDCF
	Mode	RW	on		dts4138OutMainDCFMode
	Time zone	RW	UTC		dts4138OutMainDCFTimezone
NTP slave clocks					dts4138OutLineTZServer
	Mode	RW	off		dts4138OutLineTZServerMode
	Multicast IP	RW			dts4138OutLineTZServerMCastAddr
	Multicast Port	RW	65534		dts4138OutLineTZServerMCastPort
	Poll interval NTP	RW	0 → 1sec	2^x sec	dts4138OutLineTZServerNTPInterval
	Multicast TTL	RW	1		dts4138OutLineTZServerTTL
	Table interval	RW	60	sec	dts4138OutLineTZServerTableInterval
	Entry interval	RW	1	sec	dts4138OutLineTZServerEntryInterval
	Table time zone entries	RW	-1		dts4138OutLineTZServerTable (TZ entry number)
DCF / Pulse out					dts4138OutLineDCFPulseFREQ
	Mode (off, DCF, pulse)	RW	0		dts4138OutLineDCFMode
	Time zone	RW	UTC		dts4138OutLineDCFTimezone
	Pulse interval (every second, minute...)	RW	sek		dts4138OutLineDCFPulseType
	Pulse time	RW	100	ms	dts4138OutLineDCFPulseTime
	Pulse period	RW	1	sec	dts4138OutLineDCFPulsePeriod
	Output correction	RW	0	ms	dts4138OutLineDCFPulseCorrection
	Frequency	RW	1000	Hz	dts4138OutLineDCFFrequency
IRIG / DCF-FSK-Out					dts4138OutLineIRIG
	Mode (off, IRIG)	RW	0		dts4138OutLineIRIGIRIGMode
	Time zone	RW	UTC		dts4138OutLineIRIGTimezone

	Level	RW	2000	mV	dts4138OutLineRIGOutputLevel
	Level bar	RW	200	mV	dts4138OutLineRIGAlarmLevel
Serial out					dts4138OutLineSerial
	Mode (off, on)	RW	off		dts4138OutLineSerialMode
	Time zone	RW	UTC		dts4138OutLineSerialTimezone
	Telegram file	RW	MC482STD.TEL		dts4138OutLineSerialTeleFile
	Interface:	RW	h'45		dts4138OutLineSerialComParam
	Baud rate	RW	9600		
	Databit	RW	7		
	Stopbit	RW	1		
	Parity	RW	even		
	Com mode	RW	out RS232		dts4138OutLineSerialComMode
E-mail					dts4138AlarmMailConfig
	Mode	RW	Off		dts4138MailMode
	IP addr. mail server	RW			dts4138MailServerIPAddress
	Port mail server	RW	25		dts4138MailServerPort
	Receiver address 1	RW			dts4138MailAddrDestination1
	Receiver address 2	RW			dts4138MailAddrDestination2
	Sender address ("login to mail server")	RW			dts4138MailAddrFrom
	Reply address	RW			dts4138MailAddrReply
	Error mask	RW	All set: FF FF FF FF FF FF FF FF		dts4138MailAlarmMask
	Auth. Mode	RW	off		dts4138MailAuthMode
	User name	RW			dts4138MailUser
	Password	RW			dts4138MailPassword
SNMP / - Traps					dts4138SnmConfig
	Trap mode	RW	off		dts4138SnmTrapMode
	Trap community	RW	trapmobatime		dts4138SnmTrapCommunity
	IP addr. target computer 1	RW			dts4138SnmTrapListenerIPAddress1
	Port target computer 1	RW	162		dts4138SnmTrapListenerPort1
	Trap Version 1	RW	V2c		dts4138SnmTrapVersion1
	IP addr. target computer 2	RW			dts4138SnmTrapListenerIPAddress2
	Port target computer 2	RW	162		dts4138SnmTrapListenerPort2
	Trap version 2	RW	V2c		dts4138SnmTrapVersion2
	TRAP error mask	RW	All set: FF FF FF FF FF FF FF FF		dts4138SnmTrapAlarmMask
	TO alive message	RW	off	sec	dts4138SnmTrapAliveMsgInterval
	SNMP mode	RW	on V3		dts4138SnmMode
	SNMP error mask	RW	All set: FF FF FF FF FF FF FF FF		dts4138SnmAlarmMask
	Location	RW			dts4138SnmLocation
	Contact	RW			dts4138SnmContact
	rocommunity	RW	romobatime		dts4138SnmROCommunity
	rwcommunity	RW	rwmobatime		dts4138SnmRWCommunity
	2*Access config:				
	Password	RW			dts4138SnmV3UserPasswordx
	UserSecLevel	RW	1+2: auth		dts4138SnmV3UserLevelx
	UserRead	RW	1+2: all		dts4138SnmV3UserReadx
	UserWrite	RW	1=dts1 2=dts2		dts4138SnmV3UserWritex
	View1	RW	1+2: .1.3.6.1.4.1.8072		dts4138SnmV3Viewx1
	View2	RW	1+2: .1.3.6.1.4.1.2021		dts4138SnmV3Viewx2
	View3	RW	1+2: .1.3.6.1.4.1.13842.4		dts4138SnmV3Viewx3
	View4	RW	1+2: .2		dts4138SnmV3Viewx4
	View5	RW	1+2: .2		dts4138SnmV3Viewx5
	View6	RW	1+2: .2		dts4138SnmV3Viewx6
Alarm input/output:					dts4138RelayAlarmConfig
	Error mask relay	RW	All set: FF FF FF FF FF FF FF FF		dts4138RelayAlarmMask
	Mode alarm input	RW			dts4138AlarmInput
NTP / time handling					dts4138TimeHandling
Time source:			2 (GPS, DCF)		dts4138TimeSource
	Time source	RW	0 (UTC)		dts4138TSType
	Time zone	RW	0		
	Config. stratum	RW	50ms	Stratum	dts4138TSStratumMode

	Max. Time offset to set system time OK	RW	60	us	dts4138TSMaxOffsetForTimeValid
	TO time source for error failure synch (TO)	RW	12	min	dts4138TSTimeout
	Max. stratum for error failure synch (Stratum)	RW	24	Stratum	dts4138TSStratumErrorLimit
	TO time source stratum	RW	50	h	dts4138TSStratumTimeout
	Offset change to decrement stratum by 1	RW	0	ms / stratum	dts4138TSOffsetPerStratum
	Source correction (DCF only)	RW		ms	dts4138TSDCFAdjustment
Catch-up:					
	Catch-up mode	RW	1 (set)		dts4138TSAdjustmentMode
	Max. catch-up speed	RW	100ppm	ns / sec	dts4138TSMaxAdjustmentSpeed
	Core/Quartz type	RW	0 (off)		dts4138TSQuartzType
	Synch only offset	RW	0 (off)	ms	dts4138TSOffsetSynchOnly
	RTC Mode	RW	0 (off)		dts4138TSRTCMode
	Leap second mode	RW	off		dts4138TSLeapSecMode
	Leap second date next correction	RW			dts4138TSLeapSecDate
Redundant operation:					dts4138RedundantOp
	Mode redundant operation	RW	off		dts4138RedOpMode
	Set manual master	RW			
	Max. stratum master in red. operation	RW	16	Stratum	dts4138RedOpSwitchOverStratum
	Max. time offset master to time source slave	RW	100ms	us	dts4138RedOpMaxOffsetSlaveTimeSource
	IP addr. 2. time server	RW			dts4138RedOp2ndDTSIPAddress
	Port DTS LAN link communication	RW	14338		dts4138RedOp2ndDTSIPPort
NTP:					dts4138TimeNTPServer
	4 * NTP source				dts4138NTPSourceTable (1..4)
	Addresses	RW			dts4138NTPSourceAddr
	Minpoll	RW		2^x sec	dts4138NTPSourceMinPoll
	Maxpoll	RW		2^x sec	dts4138NTPSourceMaxPoll
	Mode	RW	server		dts4138NTPSourceMode
	Prefer (-red time source)	RW	normal		dts4138NTPSourcePrefer
	Key	RW	off		dts4138NTPSourceKey
	2 * Broadcast:				
	Broadcast address	RW			dts4138NTPBroadcastAddrx
	Interval	RW	2 → 4s	2^x sec	dts4138NTPBroadcastIntervalx
	Multicast TTL	RW	1		dts4138NTPBroadcastTTLx
	Key	RW	off		dts4138NTPBroadcastKeyx
	Trusted Keys	RW			dts4138NTPKeyTrusted
	Control Key	RW	0		dts4138NTPKeyControl
	Request Key	RW	0		dts4138NTPKeyRequest
	Autokey Password	RW			dts4138NTPAutokeyPassword
					dts4138NTPKeyGeneratorCmd
					dts4138NTPKeyFileCmd
Manual Time set					dts4138TimeManualSet
	Time	W			dts4138ManualTimeSetUTC
	Diff	W		ms	dts4138ManualTimeSetDiff
Product Info					dts4138ProdInfo
	Prod. number	R			dts4138ProdInfoProdNo
	Article number	R			dts4138ProdInfoArticleNo
	HW revision	R			dts4138ProdInfoHWRevision
	HW code	R			dts4138ProdInfoHWCode
	HW name	R			dts4138ProdInfoHWName
	Firmware version	R			dts4138ProdInfoFirmwareVer
System Info					
	DTS state	R			dts4138SysStatus
	DTS alarms	R			dts4138SysAlarms
	Alarm relay state	R			
	SNMP alarms (masked)	R			
Trap Info					
	Trap state	R			
	Trap alarm number	R			

	Trap error state	R			
	Trap time	R			
	Trap message	R			
Time Info					dts4138SystemTimeInfo
	DTS stratum	R			dts4138TinfoStratum, dts4138SysStratum
	Last drift	R			dts4138TinfoLastDrift, dts4138SysLastDrift
	Last quartz corr	R			dts4138TinfoLastQCorr
	Act. corr. voltage	R			dts4138VoltageQuartzAdjust
	Current offset sec	R		sec	dts4138DCFTInfoOffsetSec
	Current offset us	R		us	dts4138DCFTInfoOffsetUsec, dts4138SysOffset
	Time of last time info	R			dts4138TinfoLastTime
	Jitter	R			dts4138TinfoSourceJitter
	Source quality	R			dts4138SysTimeReceptionQuality
	Offset of local source	R			
	Sample type	R			
	Source Type	R			dts4138SysTimeSource
	Last DCF time	R			dts4138DCFTInfoLastTime
	Last Link time	R			dts4138DCFTInfoLastLinkTime
	DCF pulse counter	R			dts4138DCFTInfoSecCount
	Link pulse counter	R			dts4138DCFTInfoLinkSecCount
	Red. State	R			dts4138SysMasterMode
	NTP source	R			dts4138NTPInfoCurrentSource
	NTP offset	R			dts4138NTPInfoSystemOffset
	NTP Jitter	R			dts4138NTPInfoSourceJitter
	NTP Stratum	R			dts4138NTPInfoStratum
	NTP Frequency	R			dts4138NTPInfoFrequency
Versions					dts4138SystemVersions
	Version DTS application	R			dts4138verApplication
	Version DTS module	R			dts4138verTimeDriver
	Version FPGA module	R			dts4138verFPGADriver
	Version FPGA	R			dts4138verFPGA
	Version NTP	R			dts4138verNTP
	Version kernel	R			dts4138verLinux
	Version busybox (CLI)	R			dts4138verCLIShell
	Version rootfs	R			dts4138verRootFS
	Version language	R			dts4138verLangResource
	Version TZ table	R			dts4138verTimezoneTable
	Version snmp master	R			dts4138verSNMPMasterAgent
	Version snmp common	R			dts4138verSNMPSubAgent
Power Info					dts4138SystemPower
	Voltage 1	R		V	
	Voltage 1	R		mv	dts4138SupplyVoltage1
	Voltage 2	R		V	
	Voltage 2	R		mv	dts4138SupplyVoltage2
	Current 1	R		A	
	Current 1	R		mA	dts4138SupplyCurrent1
	Current 2	R		A	
	Current 2	R		mA	dts4138SupplyCurrent2
2*Network Info					dts4138NetworkInfo
	IP v4	R			dts4138NetInfoIPAddr
	GW v4	R			dts4138NetInfoIPGateway
	Subnet v4	R			dts4138NetInfoIPMask
	DNS v4	R			dts4138NetInfoIPNameserver
	Hostname	R			
	Domain	R			dts4138NetInfoDomain
	DHCP	R			dts4138NetInfoDHCPMode
	Link	R			dts4138NetInfoEthernetLinkMode
	IP v6 link local	R			dts4138NetInfoIPv6AddrLocal
	IP1 v6	R			dts4138NetInfoIPv6Addr1
	IP2 v6	R			dts4138NetInfoIPv6Addr2
	GW v6	R			dts4138NetInfoIPv6Gateway
Commands					dts4138SystemMaintenance
	Update cmd.	W			dts4138SysUpdateCmd
	Backup cmd.	W			dts4138SysBackupCmd
	Restore cmd	W			dts4138SysRestoreCmd
	Restore default cmd	W			dts4138SysDefaultCmd
	Restart cmd	W			dts4138SysRestartCmd
	Copy files cmd	W			dts4138SysCopyFiles
	Set all config changed	W			dts4138SysAllChanged

H Technical data

Dimensions	19" Rack, 1HU x 28PU (H x W x D [mm]) = 483 x 44 x 125		
Weight	approx. 1.8 kg		
Ambient temperature	0 to 60°C, 10-90% relative humidity, without condensation		
Operation	Telnet / SSH / MOBA-NMS (via LAN). In addition, operation is also possible with SNMP.		
Accuracy	GPS (DCF input) to NTP server:		typical < +/- 100 µs
	GPS (DCF input) to DCF output:		typical < +/- 10 µs
	IRIG input to DCF output:		typical < +/- 50 µs
	NTP to internal time:		typical < +/- 100 µs
	Notice:	NTP reception (DTS 4138 as client or as server to external clients) can be influenced by the network traffic load and network devices (Hub, Switch, Router, Firewall...).	
		If many clients request simultaneously, the typical accuracy may not be reached.	
Time keeping (internal)	- Synchronized with GPS:		+/-10 µs to UTC
Holdover (free run):	After at least 12 hours synchronization from the time source:		
DTS 4138 -> TCXO:	at 20°C +/- 5°C:		< +/- 10 ms / day (< 0.1ppm) *
	at constant temperature*:		< +/- 1 ms / day (< 0.01ppm) *
Generally:	During power break (based on internal RTC):		
	at 20°C +/- 5°C:		< 5 ppm, but with jitter of +/- 15 ms *
	After a power failure the RTC time is available during at least 5 days (RTC buffered through a SuperCAP).		
	*measured over 24 h		
Redundant operation	- Master to slave (optical DTS link):		typical < +/- 1 µs
Time server	NTP V4	(fully V3 compatible), RFC 1305, RFC 5905	(Port 123)
	SNTP	(UDP), RFC 2030	(Port 123)
	TIME	(TCP/UDP), RFC 868	(Port 37)
	DAYTIME	(TCP/UDP), RFC 867	(Port 13)
	Max. number of NTP and SNTP client requests: > 1500 requests / sec. (e.g. client request every 60 sec. → 90000 clients)		
NTP mode	Server, Peer, Broadcast, Multicast		
NTP slave clock lines:	1 line with up to 15 different time zone entries. Communication through multicast: -RFC 3376: Internet Group Management Protocol, Version 3 -RFC 1112: Host extensions for IP multicasting -RFC 4601: Protocol Independent Multicast - Sparse Mode (PIM-SM) -RFC 3973: Protocol Independent Multicast - Dense Mode (PIM-DM)		
Time zones (see App. B)	Up to 80 predefined, 20 programmable entries (MOBA-NMS)		
2 Network interfaces	10BaseT / 100BaseTX (IEEE 802.3) Data transmission rate: Auto-negotiation / manual Connection: RJ-45 Only shielded cables permitted.		
IP Configuration	DHCP, Static IP, IPv4, IPv6		
Network services	NTP	UDP, Port 123	see timeserver
	SNTP	UDP, Port 123	see timeserver
	TIME	TCP/UDP, Port 37	see timeserver

	DAYTIME	TCP/UDP, Port 13	see timeserver
	Telnet	TCP, Port 23	operation
	SSH	TCP, Port 22	operation
	SCP	über SSH	update
	SFTP	über SSH	update
	FTP	TCP, Port 21	update
	SNMP	UDP, Port 161	operation
		UDP, Port selectable (162)	alarm notification, see SNMP
	SMTP	TCP, Port selectable (25)	alarm mail see E-Mail
	DHCP	UDP, Port 68	dyn. address allocation (client)
	DNS	TCP/UDP, Port 53	address resolution (client)
	DHCPv6	only IPV6	
	ECHO	ICMP	“Ping“
SNMP	V1, V2c, V3 with MD5 for authentication and DES for encryption (privacy).		
E-mail	Alarm reporting via SMTP. Authentication at the mail server: <ul style="list-style-type: none"> - with sender address - with username/password SMTP-Auth with LOGIN, PLAIN (RFC 4954) or CRAM-MD5 (RFC 2195) no “POP before SMTP“ possible		
DCF input	DCF receiver or DCF from GPS, active current loop Time zone: selectable Nominal 28 VDC, max. 32mA, response threshold 8mA		
AFNOR-A/C, IRIG-B12x input:	Upp: 100mV – 5500mV		
Time signal outputs	NTP V4 for slave clocks (unicast and multicast) 1 x IRIG-B output (analog and digital) 1 x DCF, programmable impulse / frequency output over RS 422 and opto coupler (current loop passive) 1 x DCF current loop interface passive 1 x Script files configurable time telegrams on RS 232, RS 422 (only send) and RS 485		
DCF output (1x)	DCF 77 time code, time zone selectable Max. time deviation with GPS source: +/- 10 µs, jitter < 10 µs DCF time code passive current interface: Vmax = 30 VDC, I _{on} = 10..15 am, I _{off} < 0.1 mA @20VDC		
DCF / impulse / frequency output (1x)	1 line for technical impulses: time zone selectable, output signal correction possible (DCF and impulse) Max. time deviation with GPS source: +/- 10 µs, Jitter < 1 µs Rise time typical: 100 ns Mode: <ul style="list-style-type: none"> - DCF time code - impulses: sec., min., h., or user-defined - frequency: 1Hz.. 5MHz (no square signal possible above 2MHz) 2 different electrical outputs with the same signal: <ul style="list-style-type: none"> - passive current loop output, opto coupler: I_{max.}=10 mA / U_{max.}=50 VDC - RS422 output: signal levels 0V / 3.3V 		

IRIG-B output (1x)	<p>1 high precision IRIG line, available as analog and digital signals. Max. time deviation to GPS (with GPS source): DC level: < +/- 10 μs Modulated: < +/- 200 μs</p> <p>Accuracy of the signal according to standard: DC level pulse rise time between the 10 and 90% amplitude points: $\leq 1 \mu$s Jitter modulated at carrier frequency: $\leq 1\%$ DC level jitter pulse-to-pulse: ≤ 200 ns</p> <p>Line mode: IRIG-B122, IRIG-B Std 12h (B122), IRIG-B123, IRIG-B DIEM, AFNOR A, AFNOR C, DCF-FSK IRIG-B126 (127), IRIG-B002, IRIG-B003, IRIG-B006 (007)</p> <p>Output voltage level (R_L=50 Ohm): 0.1 – 5.5 V_{pp} (configurable) SNR_{dB}: typical ≥ 40dB Impedance: R_i < 50 Ω Opto coupler outputs: I_{max.}=10 mA / U_{max.}=50 VDC RS422 outputs: U = typical 3.3 VDC</p>
Serial interface (1x)	<p>1 line for telegram output RS232, RS422 or RS485 Max. time deviation to internal time: +/- 10 ms, Jitter < 10 ms 300-38400 Bauds, 7 or 8 Data bits, Parity: no, even, odd, Stop bit: 1 or 2, no flow control) The description of the telegram function is provided in Appendix E. Signal levels: RS 422/485 = 0 / 3.3V ; RS232 = -6V / +6V</p>
USB plug	USB host for USB stick
Alarm contact	<p>Opening relay contact (Alarm active \rightarrow contact open). Switching load: 30 W (125 VDC or 1 A), e.g. 1 A @ 30 VDC or 60 VA (150 VAC or 1 A), e.g. 0.5 A @ 120 VAC</p>
Alarm reporting / Error reporting	<p>Alarm contact see Alarm contact E-mail see E-mail SNMP notification see SNMP trap Display see Display Alarm-LED -</p>
Alarm input	<p>18-36 VDC, max. 6mA Function configurable</p>
DTS Link	<p>Plug-in position for mini GBIC module (GigaBit Interface Converter) 1000Mbps, 3,3V (with LC connector) e.g. D-Link DEM-311GT, SX 850 nm, 1.25 Gbps/MM/3.3 V Maximal cable length depends on type of cable: - Multimode fiber with a diameter of 50 μm: max. 550 m - Multimode fiber with a diameter of 62.5 μm: max. 275 m With LX standard, longer cables can be achieved.</p>
Display	2 lines with up to 16 characters for the display of status information.
DC power supply	24 VDC +20% / -10% ; 0.7 A ; 10 W
Power supply output	Nominal 24 VDC, max. 200 mA (respectively according to power supply)

I Index

2

2 LAN Mode 34, 67

A

Accuracy 93
Alarm 44
Alarm configuration 39
Alarm input 44, 95
Alarm list 79
Alarm mask 40
Alarm relay 40, 95
Alarm status 14
Authentication 42, 64
Autoconf – Ipv6 48
Autokey 65

B

Baudrate 27
Boot time 15
Broadcast NTP 37

C

Community (SNMP) 68
Configuration 24
Configuration – Backup 54
Configuration – Restore 54
Configuration – save 59
Connection table (to fill in) 98
Connections – alarm relay 74
Connections – DCF & GPS 76
Connections – front view 73
Connections – IRIG-B12x input 74
Connections – IRIG-B12x outputs 74
Connections – rear view 74
Connectors 76
Control Key 38
Copyright 88
CRAM-MD5 42

D

Data bit 27
Daylight Saving Time 78
DAYTIME 94
DC power supply 72, 74, 95
DCF – connection 76
DCF input 75
DCF output 25, 75, 94
Default values 15, 89
DES – Data Encryption Standard 64
DHCP 47
DHCPv6 48
Display 14
DST 78
DTS (Distributed Time System) 11
DTS Link 34, 66, 74, 75, 95

E

E-mail 41, 94

F

Factory settings 15, 54, 89
Firmware 14
Front connections 73
FTP 48, 58, 94

G

GBIC 74, 75, 95
GBIC Module 66
GNSS 3000 76
GPS 4500 76

I

Initial configuration 15
Interface 83
IPv4 configuration 47
IPv6 – FTP connection 58
IPv6 configuration 48

K

Key 64

L

Language setting 45
Leap second 64
Leap second mode 39
LED description front side 13
LED-Beschreibung Rückseite 13
Lines 25
Linux 16
Login (menu) 16

M

Maintenance 54
Manual time set 39, 62
MD5 64
Menu login 16
Menu structure 17
MIB files 68
mini GBIC 66, 74, 75, 95
MOBA-NMS 11, 16, 18, 55, 93
Multicast 30, 93
Multicast address 35
Multicast NTP 37

N

Network configuration 46
Network services 48, 93
Notification 69
NTP 94
NTP as backup time source 35, 63
NTP authentication 38, 64
NTP Autokey 65

NTP broadcast	37	SNMP configuration	43, 49
NTP mode	93	SNMP traps	43, 69
NTP multicast	37	SNMP user configuration	51
NTP server	35	SNTP	94
NTP slave clocks	30, 93	Software update	55, 56
NTP symmetric keys	64	Software version	14
NTP time source	23, 36	Spring terminals	76
NTP version	63	SSH	17, 48, 94
ntp.keys	38	Standard settings	15, 89
ntpq	21	Start-up	15
O		Status menu	20
Operation (menu)	16	Stop bit	27
Operation (MOBA-NMS)	18	Stratum	62
Operation (SNMP)	69	T	
P		Telegram – definition	84
Parameters	89	Telegram file	27, 54, 60, 83
Parity	27	Telnet	16, 48, 94
Password	7, 16	Terminal	16
Password configuration	45	TIME	94
Power setting	45	Time acceptance	62
Power supply	72	Time administration	31, 61, 62
Problem solving	81	Time server	63, 93
Program file	60	Time source – configuration	32
R		Time source – time acceptance	62
Redundant NTP Multicast time server	31	Time zone	77
Redundant operation	34, 66	Time zone for displayed time	45
Request Key	38	Time zone selection	53
Restart	15, 54	Time zone server	30
RTC	93	Time zone table	77
RTC (Real Time Clock)	61	Time-keeping	33, 62
RTC mode	33	Transmission time	83
S		Trap	43, 69
SCP	59, 94	Troubleshooting	81
Script file definition	84	Trusted Key	38
Season table	77	ttl (time to live)	37
Security - network	7	U	
Serial telegrams	27, 83	Update – software	55, 56
SFTP	58, 94	Update time zone table	78
SMTP	94	USB	54, 56, 57, 60
SNMP	12, 68, 94	USB stick	14, 15
SNMP – alarm notification	71	UTC	61, 78
SNMP – alive notification	71	V	
SNMP – notification	69	Version	14
SNMP – operation	69	W	
SNMP access configuration	52	World time	30

*Headquarters/Production
Sales Worldwide*

MOSEER-BAER AG | Spitalstrasse 7 | CH-3454 Sumiswald
Tel. +41 34 432 46 46 | Fax +41 34 432 46 99
moserbaer@mobatime.com | www.mobatime.com

Sales Switzerland

MOBATIME AG | Stettbachstrasse 5 | CH-8600 Dübendorf
Tel. +41 44 802 75 75 | Fax +41 44 802 75 65
info-d@mobatime.ch | www.mobatime.ch

MOBATIME SA | En Budron H 20 | CH-1052 Le Mont-sur-Lausanne
Tél. +41 21 654 33 50 | Fax +41 21 654 33 69
info-f@mobatime.ch | www.mobatime.ch

Sales Germany/Austria

BÜRK MOBATIME GmbH
Postfach 3760 | D-78026 VS-Schwenningen
Steinkirchring 46 | D-78056 VS-Schwenningen
Tel. +49 7720 8535 0 | Fax +49 7720 8535 11
buerk@buerk-mobatime.de | www.buerk-mobatime.de